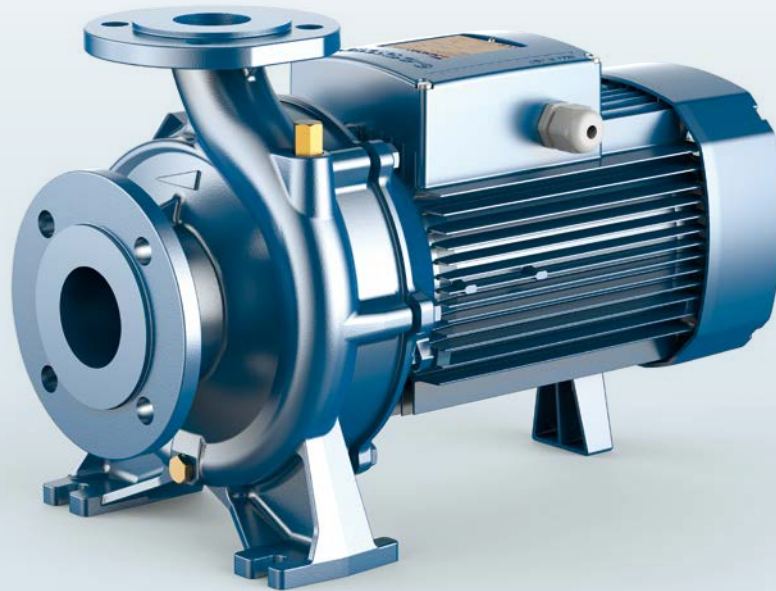

## Electrobombas centrífugas normalizadas "EN 733"

 Agua limpia

 Utilizo industrial

## CAMPO DE PRESTACIONES

- Caudal hasta **3000 l/min** (180 m<sup>3</sup>/h)
- Altura manométrica hasta **24 m**

## LÍMITES DE UTILIZO

- Altura de aspiración manométrica hasta **7 m**
- Temperatura del líquido de **-10 °C** hasta **+90 °C**
- Temperatura ambiente de **-10 °C** hasta **+40 °C**
- Presión máxima en el cuerpo bomba **10 bar** (PN10)
- Funcionamiento continuo **S1**

## EJECUCION Y NORMAS DE SEGURIDAD

EN 60335-1  
IEC 60335-1  
CEI 61-150

EN 60034-1  
IEC 60034-1  
CEI 2-3



Dimensiones del cuerpo de la bomba conformes a la norma **EN 733**

**REGLAMENTO (UE) N. 547/2012**

## UTILIZOS E INSTALACIONES

- Abastecimiento hídrico
- Presurización
- Irrigación
- Circulación del agua en instalaciones de climatización
- Instalaciones de lavado
- Instalaciones Anti Incendio
- Industria
- Agricultura

La instalación se debe realizar en lugares cerrados, bien aireados y protegidos de la intemperie.

## EJECUCION BAJO PEDIDO

- KIT contrabridas completo de tornillos, tuercas y juntas
- Otros voltajes o frecuencia 60 Hz
- Para líquidos con temperaturas más altas o más bajas
- Para ambientes con temperaturas más altas o más bajas

## GARANTIA

2 años según nuestras condiciones generales de venta

## CERTIFICACIONES

Empresa con sistema de gestión certificado DNV  
ISO 9001: CALIDAD



## CAMPO DE PRESTACIONES

50 Hz n= 1450 min<sup>-1</sup>

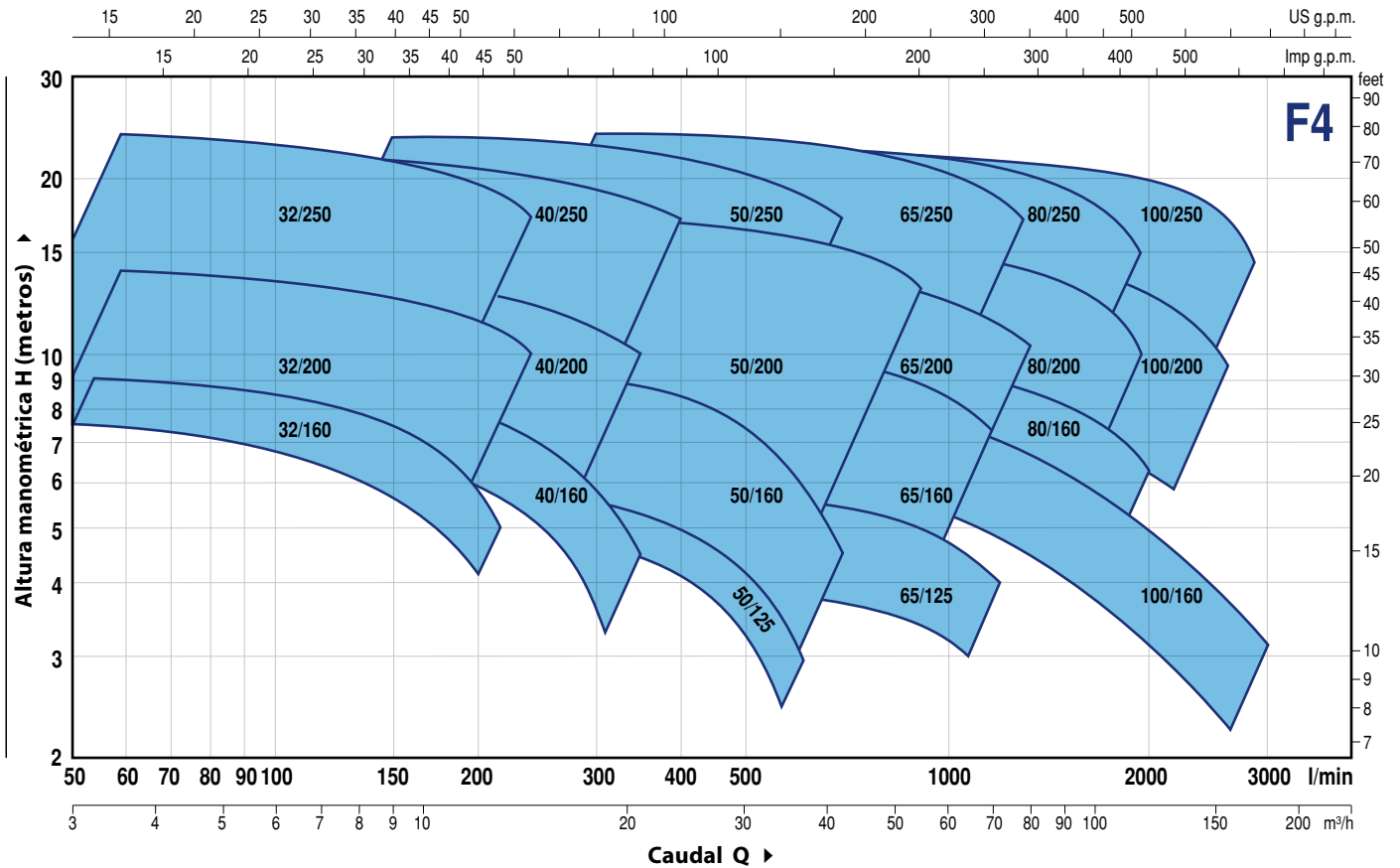

## DATOS DE PRESTACIONES

50 Hz n= 1450 min<sup>-1</sup>

MODELO	POTENCIA (P <sub>2</sub> )			PRESTACIONES	
	kW	HP	▲	Q l/min	H metros
<b>F4-32/160B</b>	0.37	0.5	IE2	50 – 200	7.5 – 4.5
<b>F4-32/160A</b>	0.37	0.5		50 – 225	9 – 5
<b>F4-32/200B</b>	0.75	1	IE3	50 – 250	12.5 – 9
<b>F4-32/200A</b>	1.1	1.5		50 – 250	14 – 10.5
<b>F4-32/200BH</b>	0.75	1	IE3	50 – 150	11.3 – 9.2
<b>F4-32/200AH</b>	0.75	1		50 – 160	13.8 – 11
<b>F4-32/250C</b>	1.1	1.5	IE3	50 – 220	18.4 – 15
<b>F4-32/250B</b>	1.5	2		50 – 250	21.7 – 17.4
<b>F4-32/250A</b>	2.2	3		50 – 270	23.8 – 18.7
<b>F4-40/160B</b>	0.37	0.5	IE2	50 – 320	7.5 – 3.5
<b>F4-40/160A</b>	0.55	0.75		50 – 350	9 – 4.5
<b>F4-40/200B</b>	0.75	1	IE3	50 – 350	11.5 – 7
<b>F4-40/200A</b>	1.1	1.5		50 – 350	13.8 – 10
<b>F4-40/250C</b>	1.1	1.5	IE3	50 – 400	15.5 – 10
<b>F4-40/250B</b>	1.5	2		50 – 400	17.5 – 12
<b>F4-40/250A</b>	2.2	3		50 – 400	22 – 17
<b>F4-50/125B</b>	0.55	0.75	IE2	150 – 600	5 – 2
<b>F4-50/125A</b>	0.55	0.75		150 – 600	6 – 3
<b>F4-50/160B</b>	0.75	1	IE3	150 – 650	8 – 3.8
<b>F4-50/160A</b>	1.1	1.5		150 – 700	9.3 – 4.5
<b>F4-50/200C</b>	1.5	2	IE3	200 – 850	11 – 7.5
<b>F4-50/200B</b>	2.2	3		200 – 850	13 – 9.5
<b>F4-50/200A</b>	2.2	3	IE3	200 – 900	15 – 11.2
<b>F4-50/200AR</b>	3	4		200 – 900	17 – 13.2
<b>F4-50/250D</b>	1.1	1.5	IE3	150 – 650	12.5 – 5
<b>F4-50/250C</b>	1.5	2		150 – 700	14 – 5
<b>F4-50/250B</b>	2.2	3		150 – 700	18 – 10.5
<b>F4-50/250A</b>	2.2	3		150 – 700	20 – 13
<b>F4-50/250AR</b>	3	4		150 – 700	23.5 – 17

MODELO	POTENCIA (P <sub>2</sub> )			PRESTACIONES	
	kW	HP	▲	Q l/min	H metros
<b>F4-65/125B</b>	0.75	1	IE3	300 – 1100	4.7 – 3
<b>F4-65/125A</b>	1.1	1.5		300 – 1200	5.7 – 4
<b>F4-65/160C</b>	1.1	1.5	IE3	300 – 1100	7.5 – 5.5
<b>F4-65/160B</b>	1.5	2		300 – 1200	9.1 – 5.7
<b>F4-65/160A</b>	2.2	3	IE3	300 – 1200	10.1 – 7
<b>F4-65/200A</b>	2.2	3		300 – 1250	12 – 8.5
<b>F4-65/200AR</b>	3	4	IE3	300 – 1300	14 – 10
<b>F4-65/250B</b>	4	5.5		200 – 1250	21.8 – 15.5
<b>F4-65/250A</b>	5.5	7.5	IE3	200 – 1300	23.5 – 17
<b>F4-80/160D</b>	1.5	2		300 – 2000	6.3 – 2.5
<b>F4-80/160C</b>	2.2	3	IE3	300 – 2000	7.5 – 3.8
<b>F4-80/160B</b>	2.2	3		300 – 2000	8.8 – 5
<b>F4-80/160A</b>	3	4	IE3	300 – 2000	10 – 6.2
<b>F4-80/200B</b>	4	5.5		300 – 1800	14 – 9
<b>F4-80/200A</b>	5.5	7.5	IE3	300 – 1900	15.5 – 10.5
<b>F4-80/250B</b>	5.5	7.5		300 – 1800	19.5 – 13.5
<b>F4-80/250A</b>	7.5	10	IE3	300 – 1950	22 – 15
<b>F4-100/160B</b>	2.2	3		400 – 2600	8.3 – 3.5
<b>F4-100/160A</b>	3	4	IE3	400 – 2800	10 – 4.7
<b>F4-100/200C</b>	4	5.5		400 – 2300	12.7 – 7
<b>F4-100/200B</b>	5.5	7.5	IE3	400 – 2400	14.2 – 8.5
<b>F4-100/200A</b>	5.5	7.5		400 – 2600	15.8 – 9.5
<b>F4-100/250B</b>	7.5	10	IE3	400 – 2600	18.5 – 11.5
<b>F4-100/250A</b>	9.2	12.5		400 – 2900	22 – 13.5

Q = Caudal

H = Altura manométrica total

Tolerancia de las curvas de prestación según EN ISO 9906 Grado 3B.

▲ Clase de rendimiento del motor trifásico (IEC 60034-30-1)

# F4-32/160

## CURVAS Y DATOS DE PRESTACIONES

50 Hz n = 1450 min<sup>-1</sup> HS = 0 m

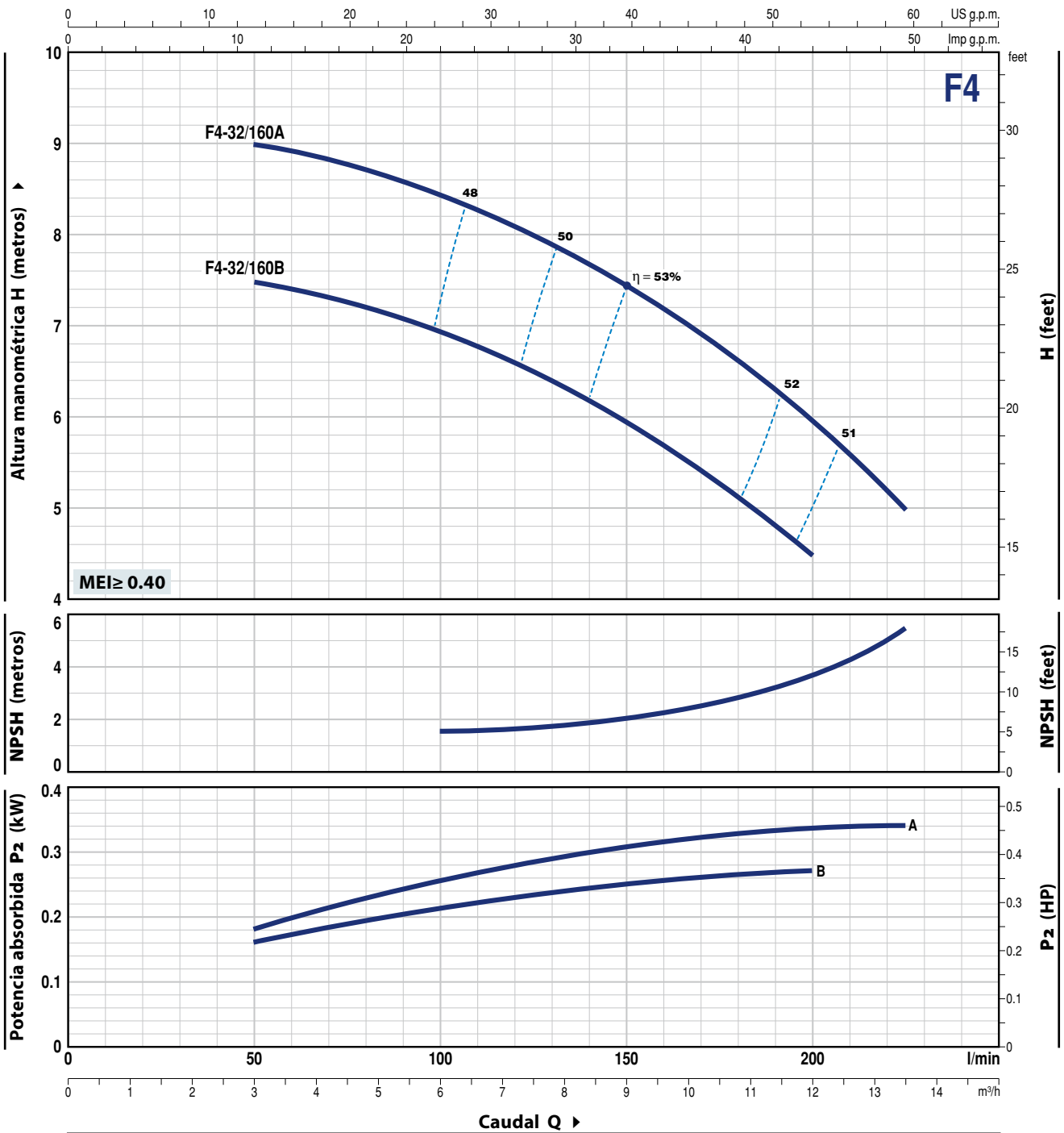

MODELO	POTENCIA (P <sub>2</sub> )		Q	Caudal Q								
	kW	HP		m <sup>3</sup> /h	3	4.5	6	7.5	9	10.8	12	13.5
Trifásica			l/min	50	75	100	125	150	180	200	225	
F4-32/160B	0.37	0.5	H metros	7.5	7.3	6.9	6.5	6	5.1	4.5		
F4-32/160A	0.37	0.5		9	8.8	8.4	8	7.5	6.6	6	5	

Q = Caudal H = Altura manométrica total HS = Altura de aspiración

Tolerancia de las curvas de prestación según EN ISO 9906 Grado 3B.

## CURVAS Y DATOS DE PRESTACIONES

50 Hz n = 1450 min<sup>-1</sup> HS = 0 m

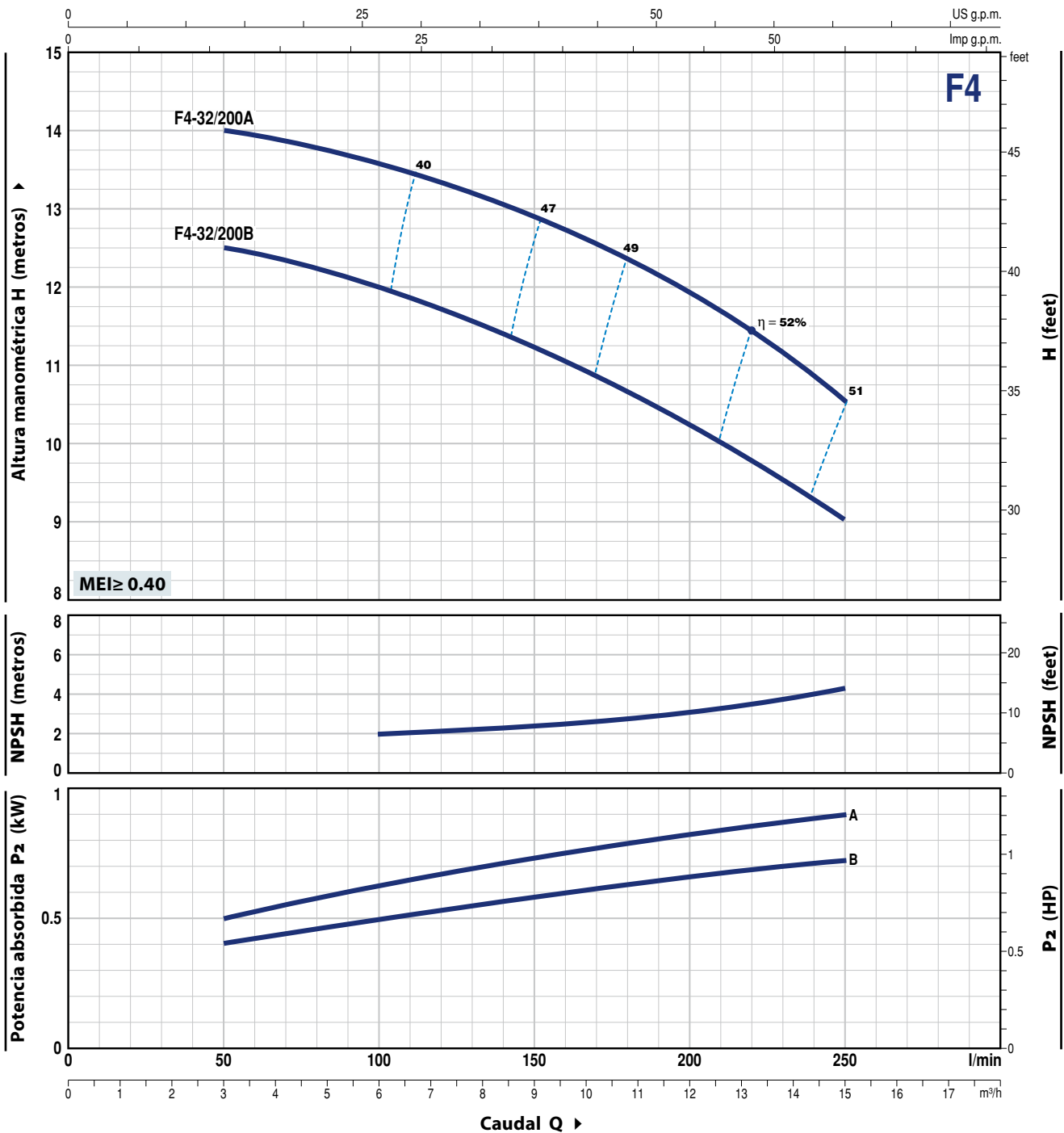

MODELO	POTENCIA (P <sub>2</sub> )		Q	Caudal				
	kW	HP		m <sup>3</sup> /h	l/min	l/min	l/min	l/min
Trifásica				3	6	9	12	15
				50	100	150	200	250
<b>F4-32/200B</b>	0.75	1	H metros	12.5	12	11.2	10.3	9
<b>F4-32/200A</b>	1.1	1.5		14	13.6	12.8	11.9	10.5

Q = Caudal H = Altura manométrica total HS = Altura de aspiración

Tolerancia de las curvas de prestación según EN ISO 9906 Grado 3B.

# F4-32/200H

CURVAS Y DATOS DE PRESTACIONES

50 Hz n = 1450 min<sup>-1</sup> HS = 0 m

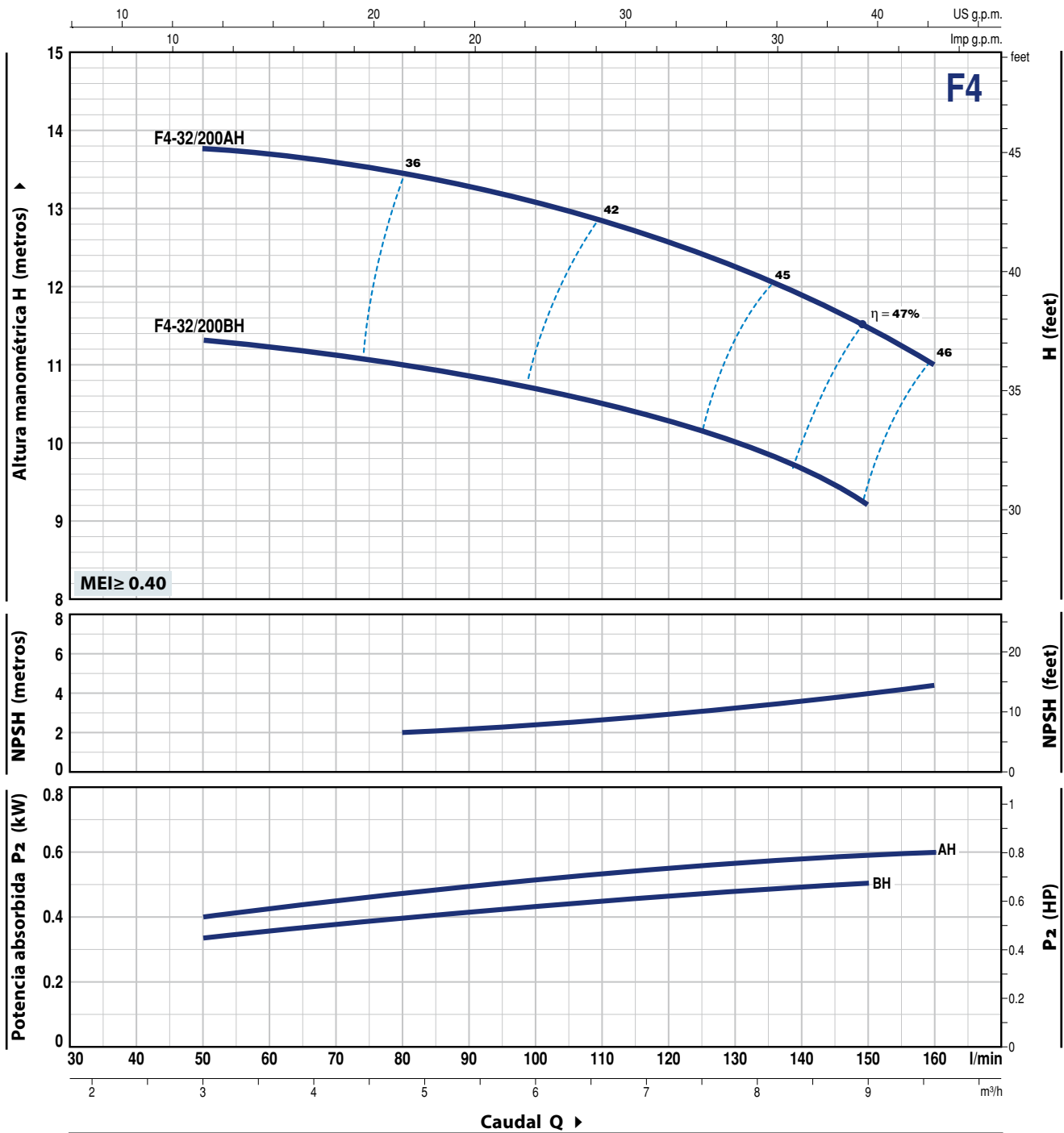

MODELO	POTENCIA (P <sub>2</sub> )		Q m <sup>3</sup> /h l/min	3	4.2	5.4	6.6	7.8	9	9.6
	kW	HP		50	70	90	110	130	150	160
F4-32/200BH	0.75	1	H metros	11.3	11.1	10.8	10.5	10	9.2	
F4-32/200AH	0.75	1		13.8	13.6	13.3	12.8	12.2	11.5	11

Q = Caudal H = Altura manométrica total HS = Altura de aspiración

Tolerancia de las curvas de prestación según EN ISO 9906 Grado 3B.

## CURVAS Y DATOS DE PRESTACIONES

50 Hz n = 1450 min<sup>-1</sup> HS = 0 m

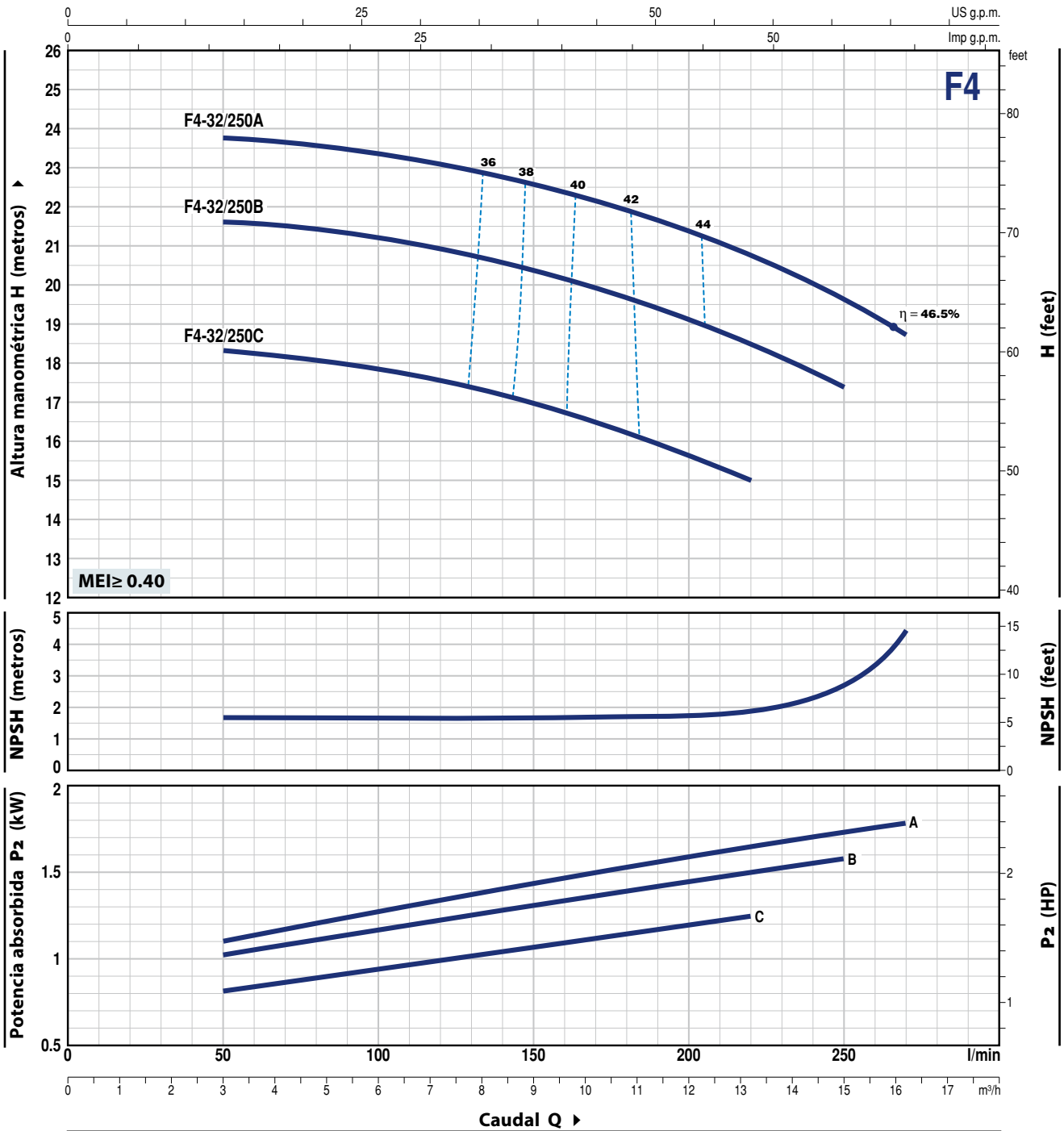

MODELO	POTENCIA (P <sub>2</sub> )		Q	Flow Rate (m³/h)											
	kW	HP		3	4.5	6	7.5	9	10.5	13.2	15	16.2			
Trifásica			l/min	50	75	100	125	150	175	220	250	270			
F4-32/250C	1.1	1.5	H metros	18.4	18.1	17.8	17.5	17	16.4	15					
F4-32/250B	1.5	2		21.7	21.5	21.2	20.9	20.4	19.8	18.5	17.4				
F4-32/250A	2.2	3		23.8	23.6	23.4	23	22.6	22.1	20.8	19.6	18.7			

Q = Caudal H = Altura manométrica total HS = Altura de aspiración

Tolerancia de las curvas de prestación según EN ISO 9906 Grado 3B.

# F4-40/160

## CURVAS Y DATOS DE PRESTACIONES

50 Hz n = 1450 min<sup>-1</sup> HS = 0 m

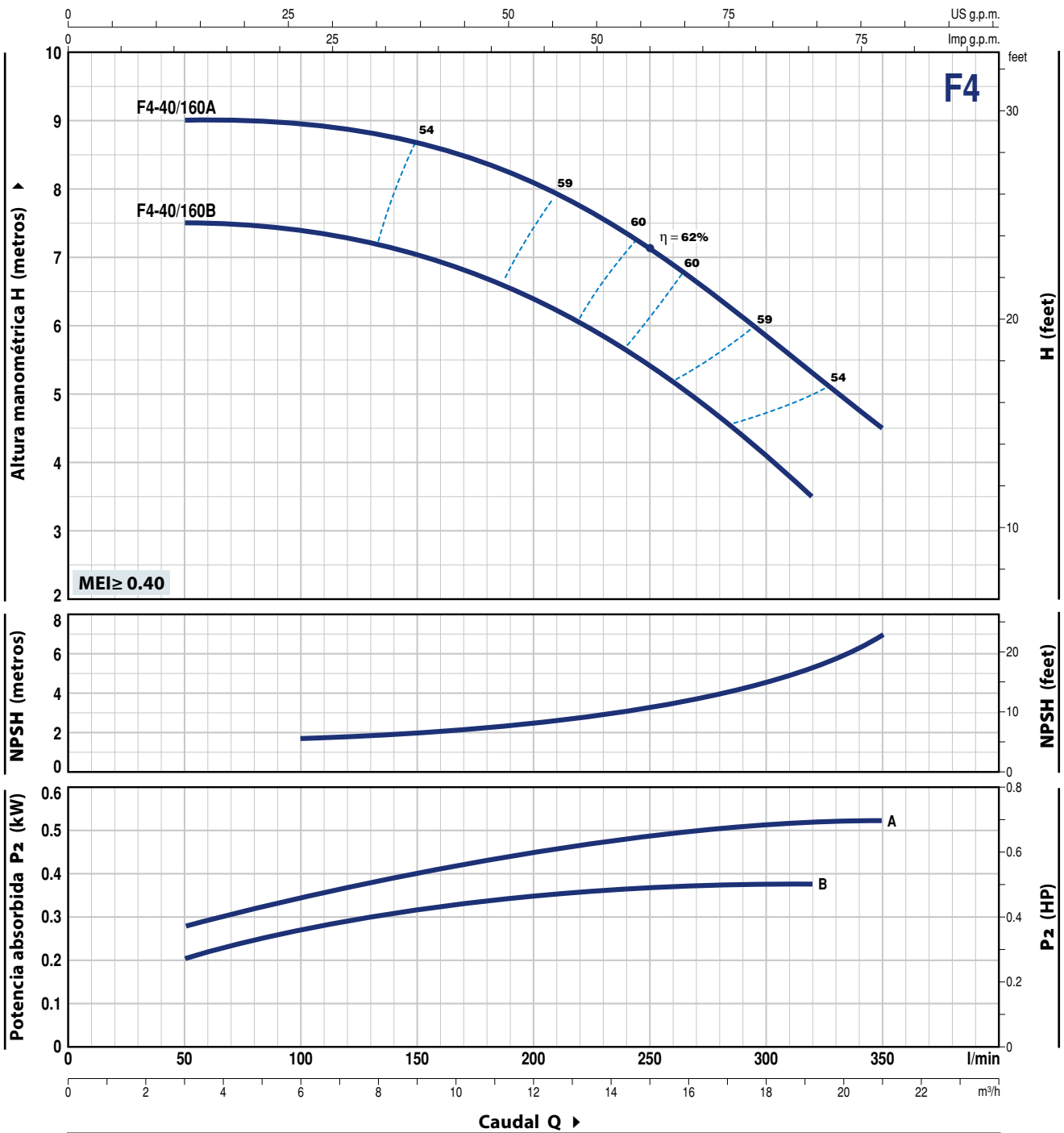

MODELO	POTENCIA (P <sub>2</sub> )		Q	Caudal										
	kW	HP		m <sup>3</sup> /h	3	6	9	12	15	18	19.2	21		
Trifásica			l/min	50	100	150	200	250	300	320	350			
F4-40/160B	0.37	0.5	H metros	7.5	7.4	7	6.4	5.4	4.1	3.5				
F4-40/160A	0.55	0.75		9	8.9	8.7	8.1	7.1	5.8	5.3	4.5			

Q = Caudal H = Altura manométrica total HS = Altura de aspiración

Tolerancia de las curvas de prestación según EN ISO 9906 Grado 3B.

## CURVAS Y DATOS DE PRESTACIONES

50 Hz n = 1450 min<sup>-1</sup> HS = 0 m

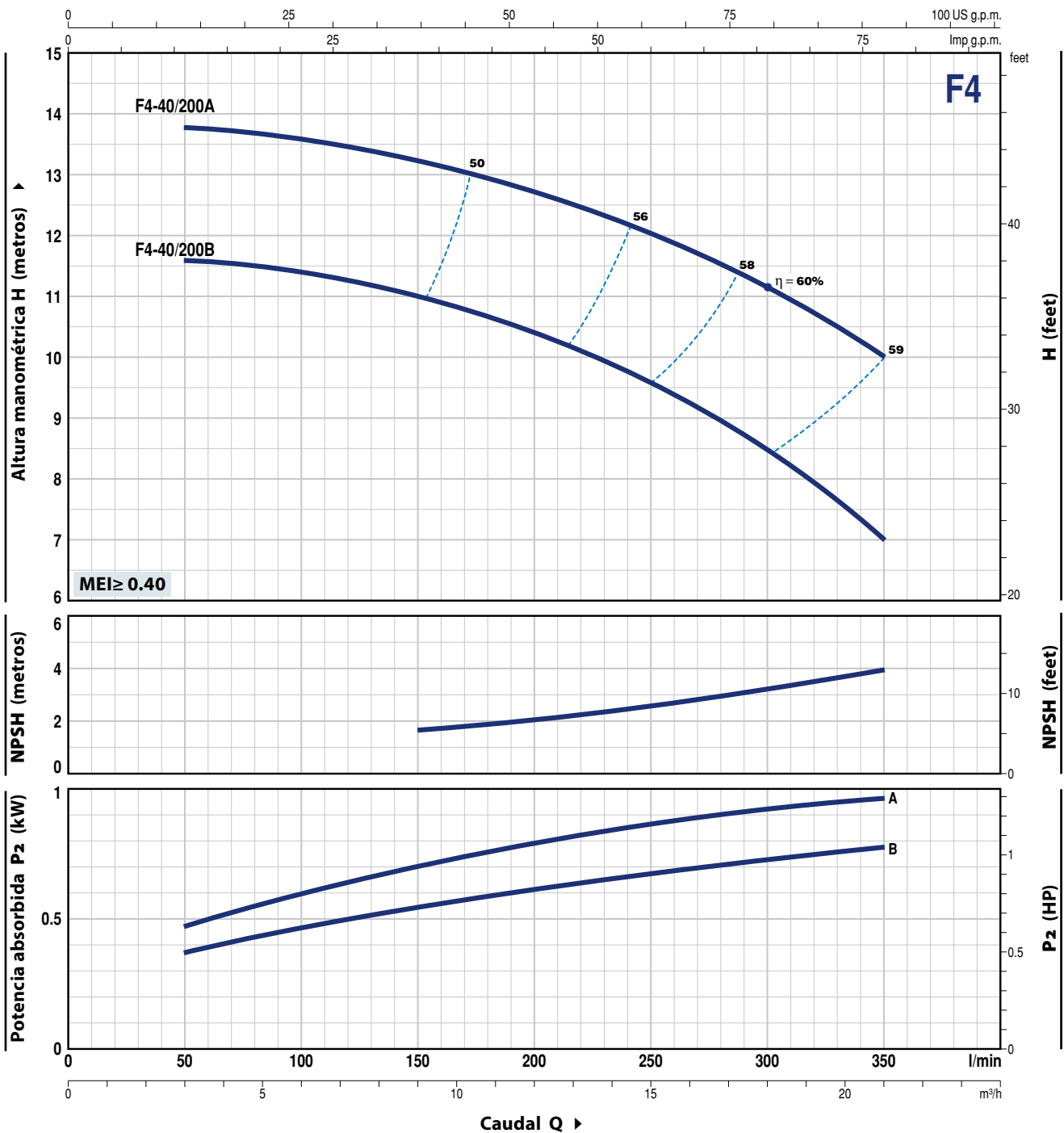

MODELO	POTENCIA (P <sub>2</sub> )		Q	3	6	9	12	15	18	21
	kW	HP		l/min	50	100	150	200	250	300
F4-40/200B	0.75	1	H metros	11.5	11.4	11	10.4	9.5	8.5	7
F4-40/200A	1.1	1.5		13.8	13.6	13.2	12.7	12	11.1	10

Q = Caudal H = Altura manométrica total HS = Altura de aspiración

Tolerancia de las curvas de prestación según EN ISO 9906 Grado 3B.



# F4-40/250

## CURVAS Y DATOS DE PRESTACIONES

50 Hz n = 1450 min<sup>-1</sup> HS = 0 m

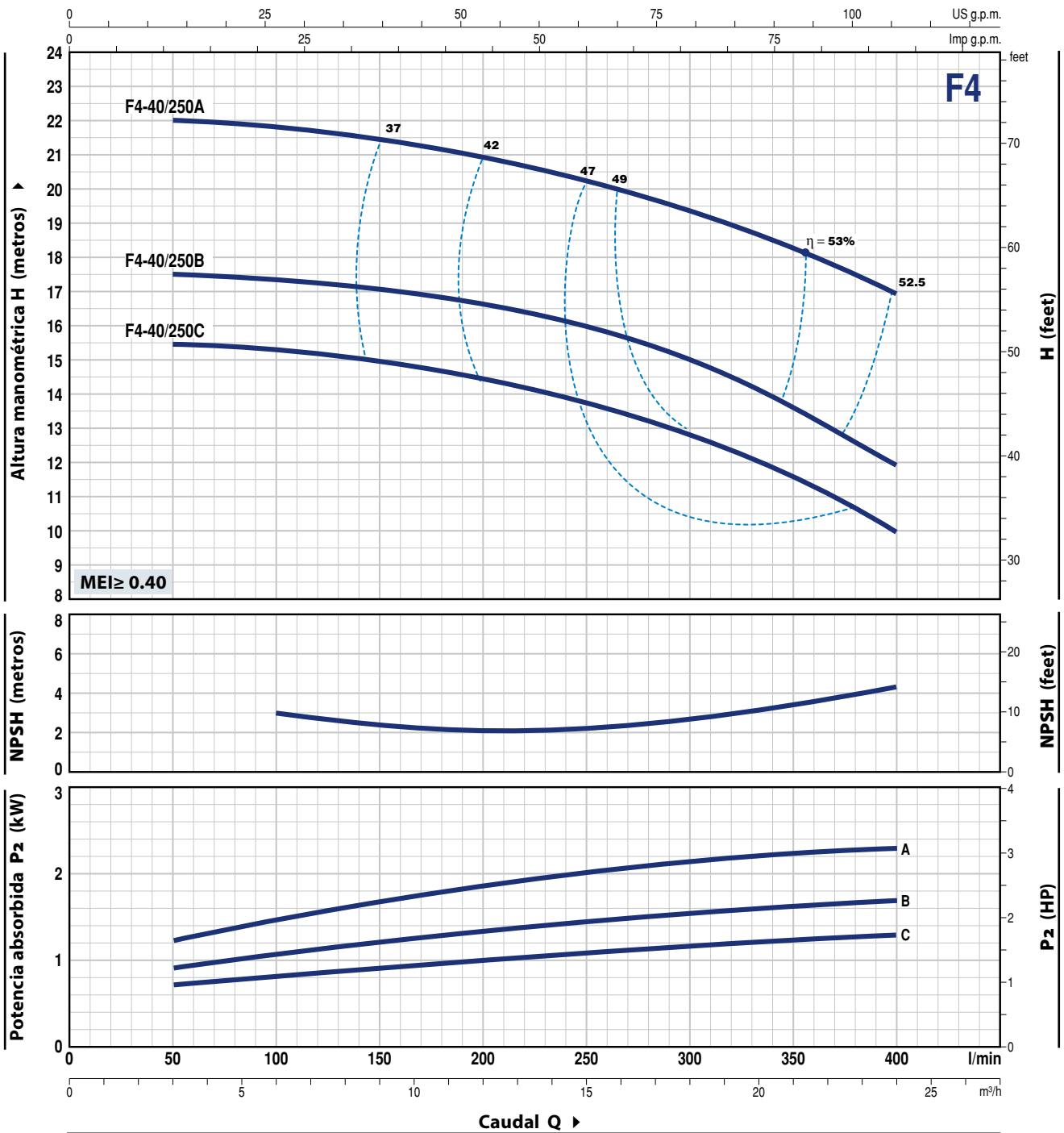

MODELO	POTENCIA (P <sub>2</sub> )		Q	3	6	9	12	15	18	21	24
	kW	HP		l/min	50	100	150	200	250	300	350
F4-40/250C	1.1	1.5	H metros	15.5	15.2	15	14.5	13.6	12.9	11.5	10
F4-40/250B	1.5	2		17.5	17.2	17	16.5	16	15	13.5	12
F4-40/250A	2.2	3		22	21.9	21.5	21	20.2	19.2	18.2	17

Q = Caudal H = Altura manométrica total HS = Altura de aspiración

Tolerancia de las curvas de prestación según EN ISO 9906 Grado 3B.

## CURVAS Y DATOS DE PRESTACIONES

50 Hz n = 1450 min<sup>-1</sup> HS = 0 m

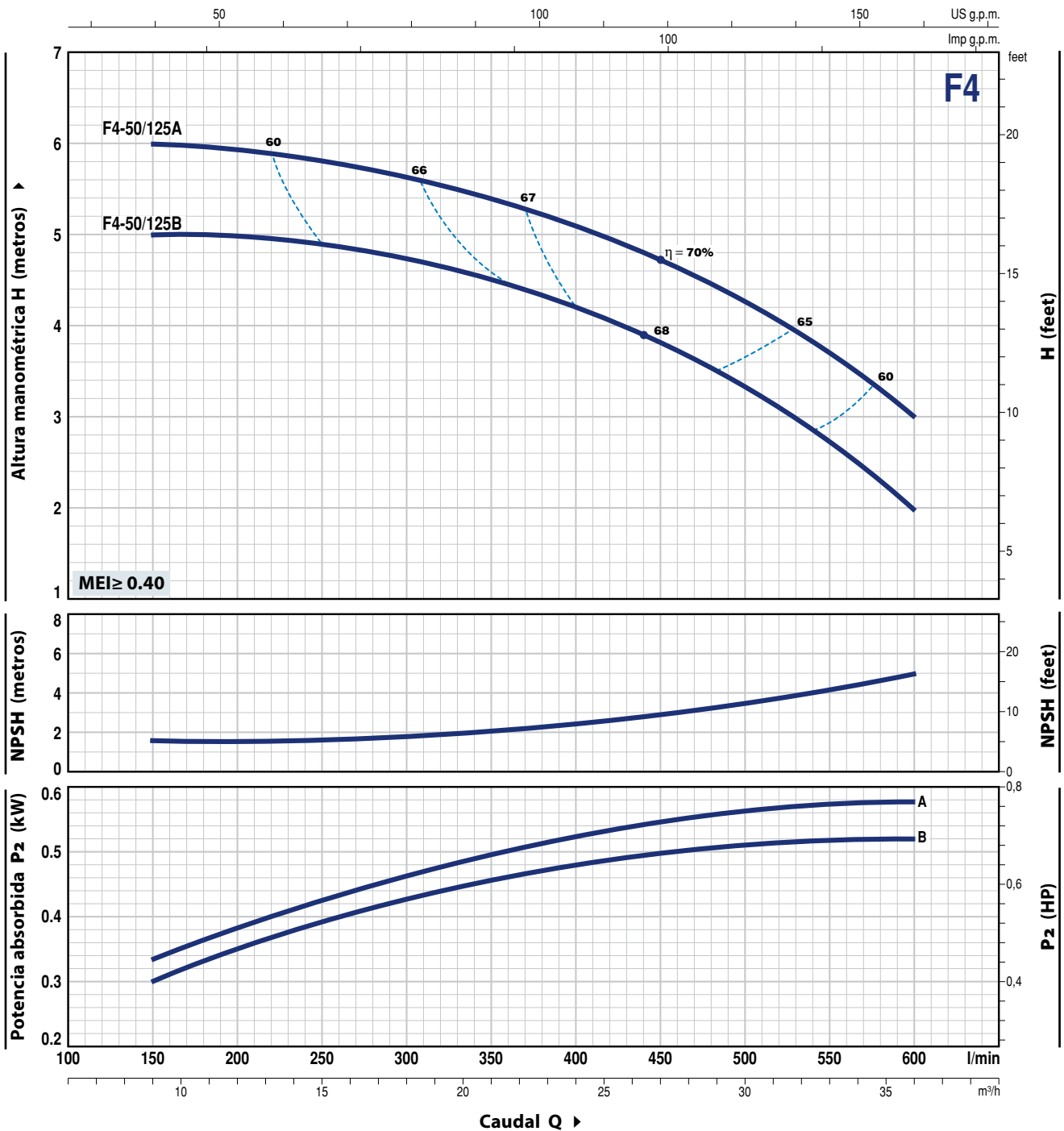

MODELO	POTENCIA (P <sub>2</sub> )		Q	Flow Rate											
	kW	HP		m <sup>3</sup> /h	9	12	15	17	21	24	27	30	33	36	
Trifásica			l/min	150	200	250	300	350	400	450	500	550	600		
F4-50/125B	0.55	0.75	H metros	5	5	4.9	4.7	4.5	4.2	3.8	3.3	2.7	2		
F4-50/125A	0.55	0.75		6	5.9	5.8	5.6	5.4	5.1	4.7	4.2	3.7	3		

Q = Caudal H = Altura manométrica total HS = Altura de aspiración

Tolerancia de las curvas de prestación según EN ISO 9906 Grado 3B.

# F4-50/160

CURVAS Y DATOS DE PRESTACIONES

50 Hz n= 1450 min<sup>-1</sup> HS= 0 m

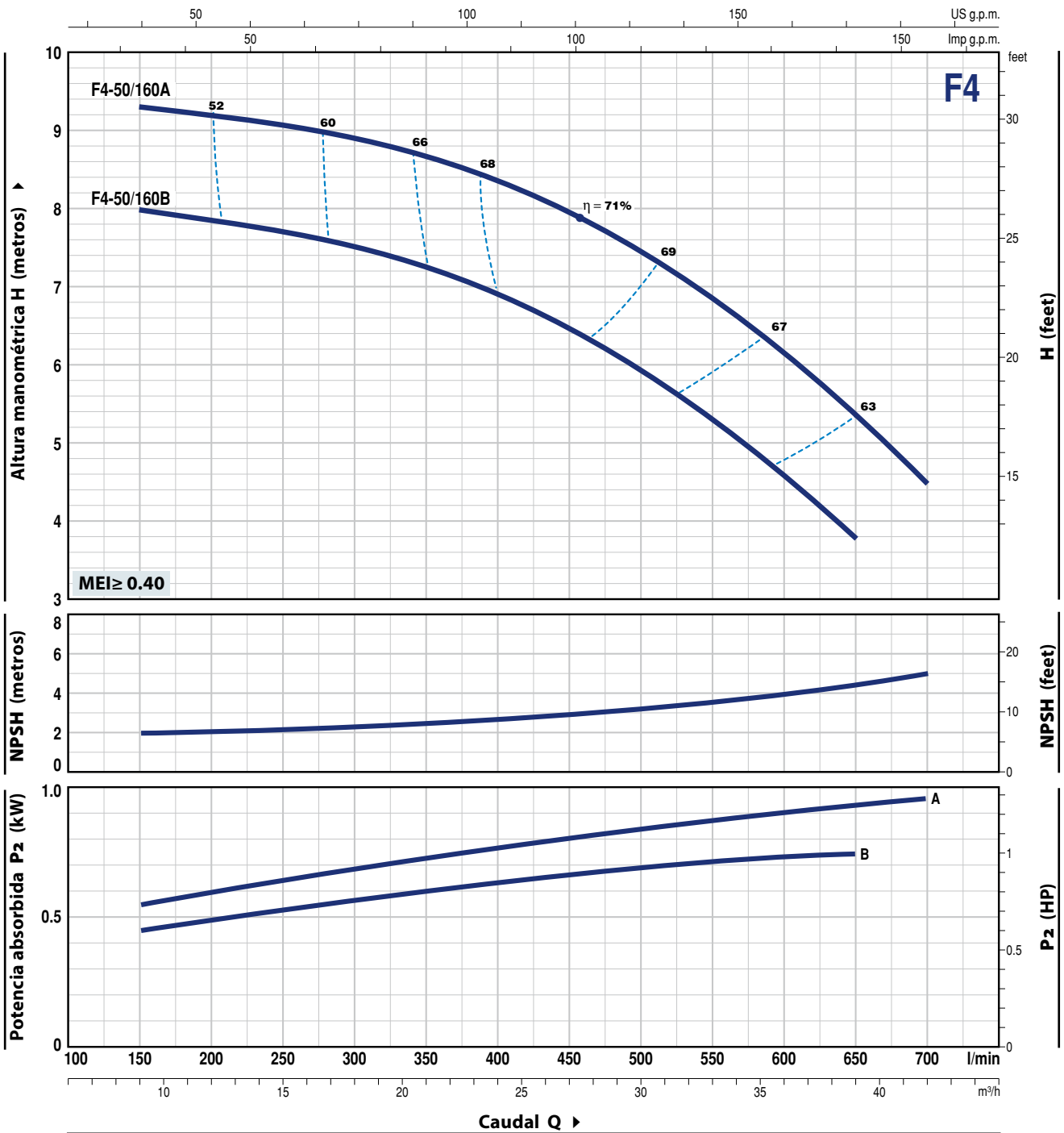

MODELO	POTENCIA (P <sub>2</sub> )		Q	Flow Rate													
	kW	HP		m <sup>3</sup> /h	9	12	15	17	21	24	27	30	33	36	39	42	
Trifásica			l/min	150	200	250	300	350	400	450	500	550	600	650	700		
F4-50/160B	0.75	1	H metros	8	7.8	7.7	7.5	7.2	6.9	6.5	5.9	5.3	4.6	3.8			
F4-50/160A	1.1	1.5		9.3	9.2	9.1	8.9	8.7	8.4	8	7.4	6.8	6.2	5.4	4.5		

Q =Caudal H=Altura manométrica total HS = Altura de aspiración

Tolerancia de las curvas de prestación según EN ISO 9906 Grado 3B.

## CURVAS Y DATOS DE PRESTACIONES

50 Hz n = 1450 min<sup>-1</sup> HS = 0 m

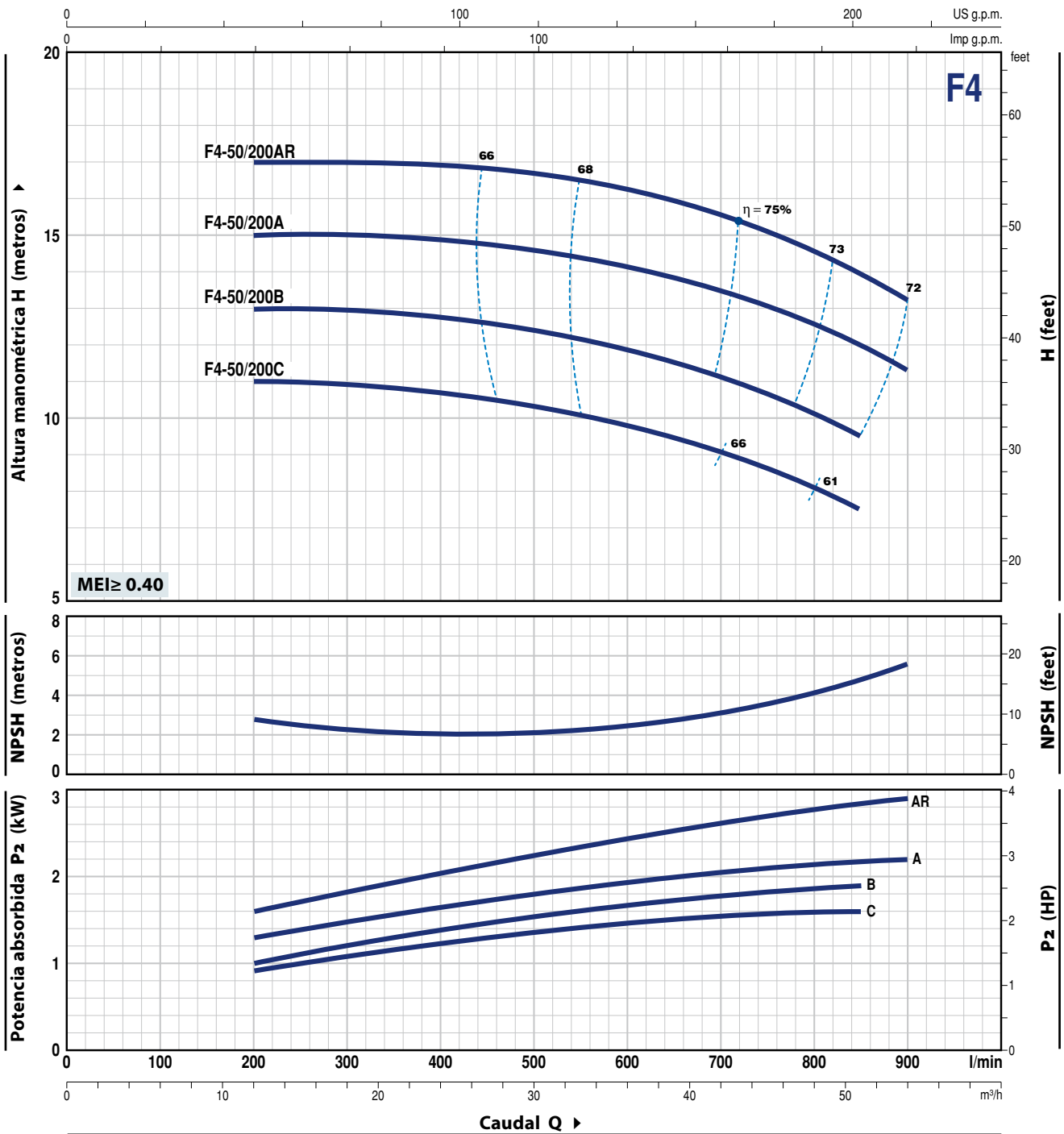

MODELO	POTENCIA (P <sub>2</sub> )		Q	Flow Rate (Q)											
	kW	HP		m <sup>3</sup> /h	12	17	24	30	36	42	48	51	54		
Trifásica			l/min	200	300	400	500	600	700	800	850	900			
F4-50/200C	1.5	2	H metros	11	11	10.8	10.3	9.8	9	8	7.5				
F4-50/200B	2.2	3		13	13	12.8	12.4	11.9	11.1	10.1	9.5				
F4-50/200A	2.2	3		15	15	14.9	14.6	14.1	13.5	12.5	12	11.2			
F4-50/200AR	3	4		17	17	16.9	16.7	16.2	15.5	14.5	14	13.2			

Q = Caudal H = Altura manométrica total HS = Altura de aspiración

Tolerancia de las curvas de prestación según EN ISO 9906 Grado 3B.

# F4-50/250

## CURVAS Y DATOS DE PRESTACIONES

50 Hz n = 1450 min<sup>-1</sup> HS = 0 m

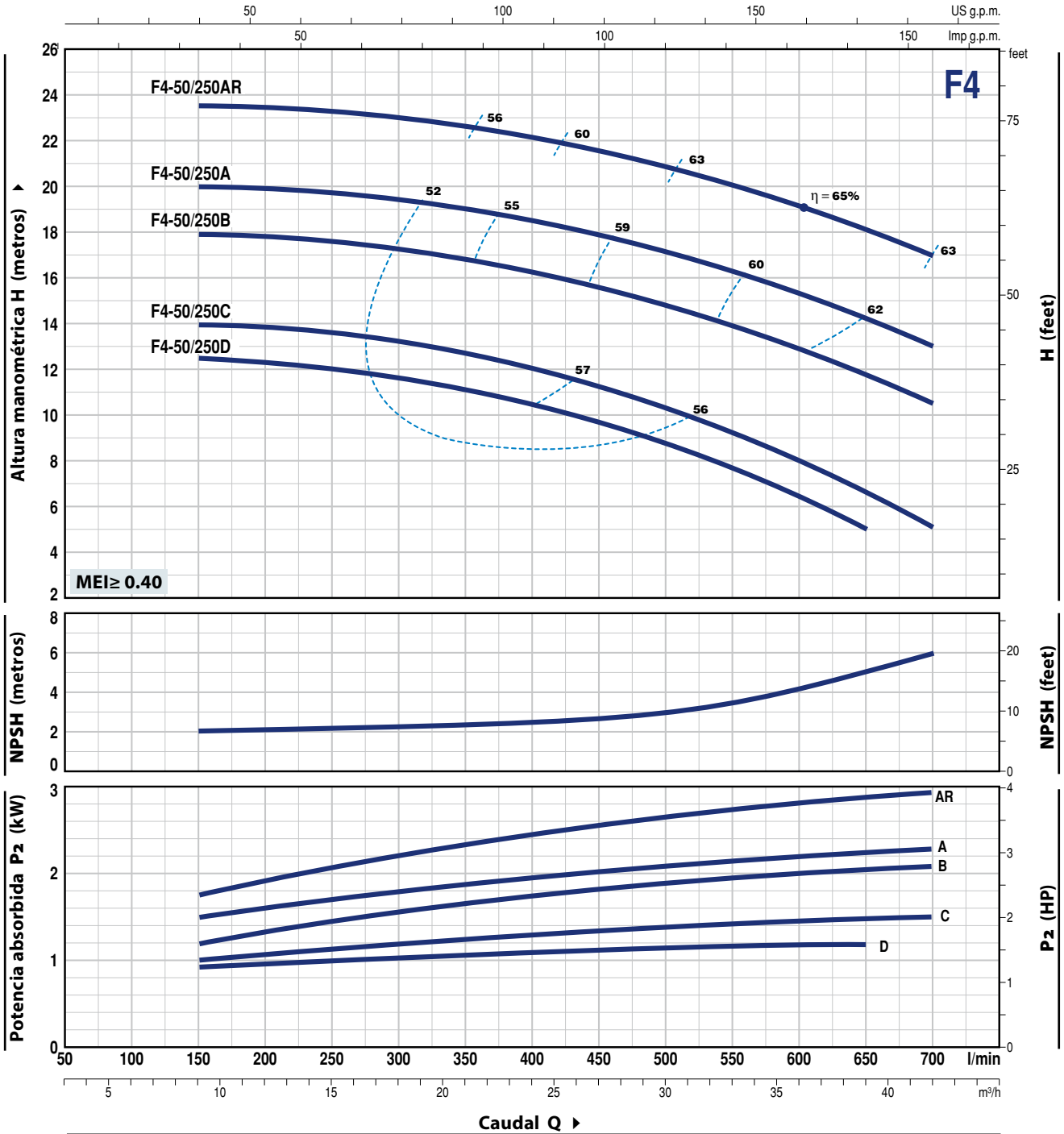

MODELO	POTENCIA (P <sub>2</sub> )		Q	Caudal Q														
	kW	HP		m <sup>3</sup> /h	9	12	15	18	21	24	27	30	33	36	39	42		
Trifásica			l/min	150	200	250	300	350	400	450	500	550	600	650	700			
F4-50/250D	1.1	1.5	H metros	12.5	12.3	12	11.5	11.1	10.5	9.8	8.8	7.8	6.5	5				
F4-50/250C	1.5	2		14	13.9	13.6	13.2	12.8	12	11.2	10.2	9.2	8	6.6	5			
F4-50/250B	2.2	3		18	17.9	17.6	17.2	16.8	16.2	15.5	14.8	14	13	11.8	10.5			
F4-50/250A	2.2	3		20	19.9	19.7	19.5	19	18.5	18	17.2	16.2	15.3	14.2	13			
F4-50/250AR	3	4		23.5	23.4	23.2	23	22.6	22.1	21.6	21	20	19	18	17			

Q = Caudal H = Altura manométrica total HS = Altura de aspiración

Tolerancia de las curvas de prestación según EN ISO 9906 Grado 3B.

## CURVAS Y DATOS DE PRESTACIONES

50 Hz n = 1450 min<sup>-1</sup> HS = 0 m

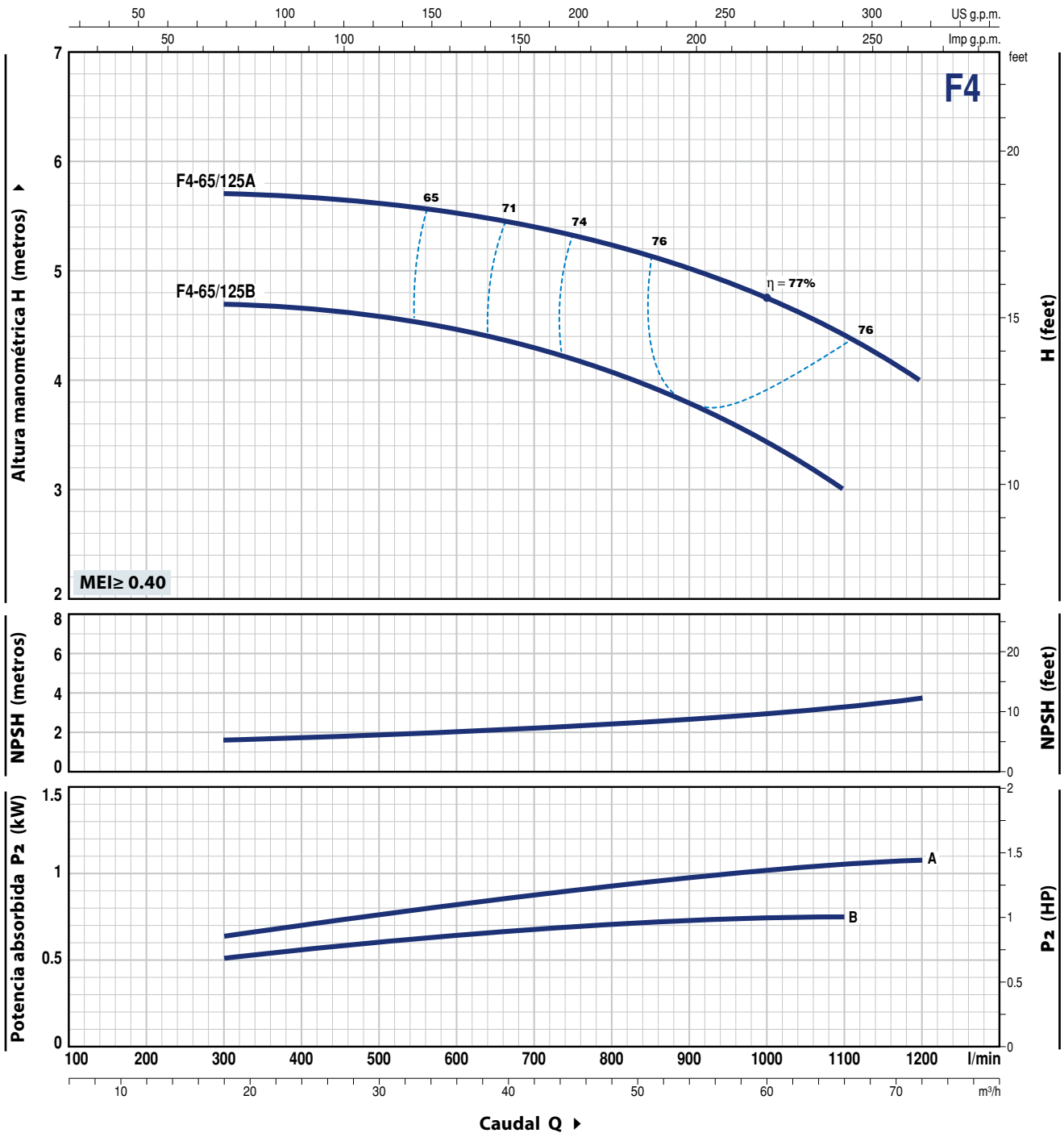

MODELO	POTENCIA (P <sub>2</sub> )		Q	Flow Rate												
	kW	HP		m <sup>3</sup> /h	18	24	30	36	42	48	54	60	66	72		
Trifásica			l/min	300	400	500	600	700	800	900	1000	1100	1200			
F4-65/125B	0.75	1	H metros	4.7	4.7	4.6	4.5	4.3	4.1	3.8	3.4	3				
F4-65/125A	1.1	1.5		5.7	5.7	5.6	5.5	5.4	5.2	5	4.7	4.4	4			

Q = Caudal H = Altura manométrica total HS = Altura de aspiración

Tolerancia de las curvas de prestación según EN ISO 9906 Grado 3B.

# F4-65/160

## CURVAS Y DATOS DE PRESTACIONES

50 Hz n= 1450 min<sup>-1</sup> HS= 0 m

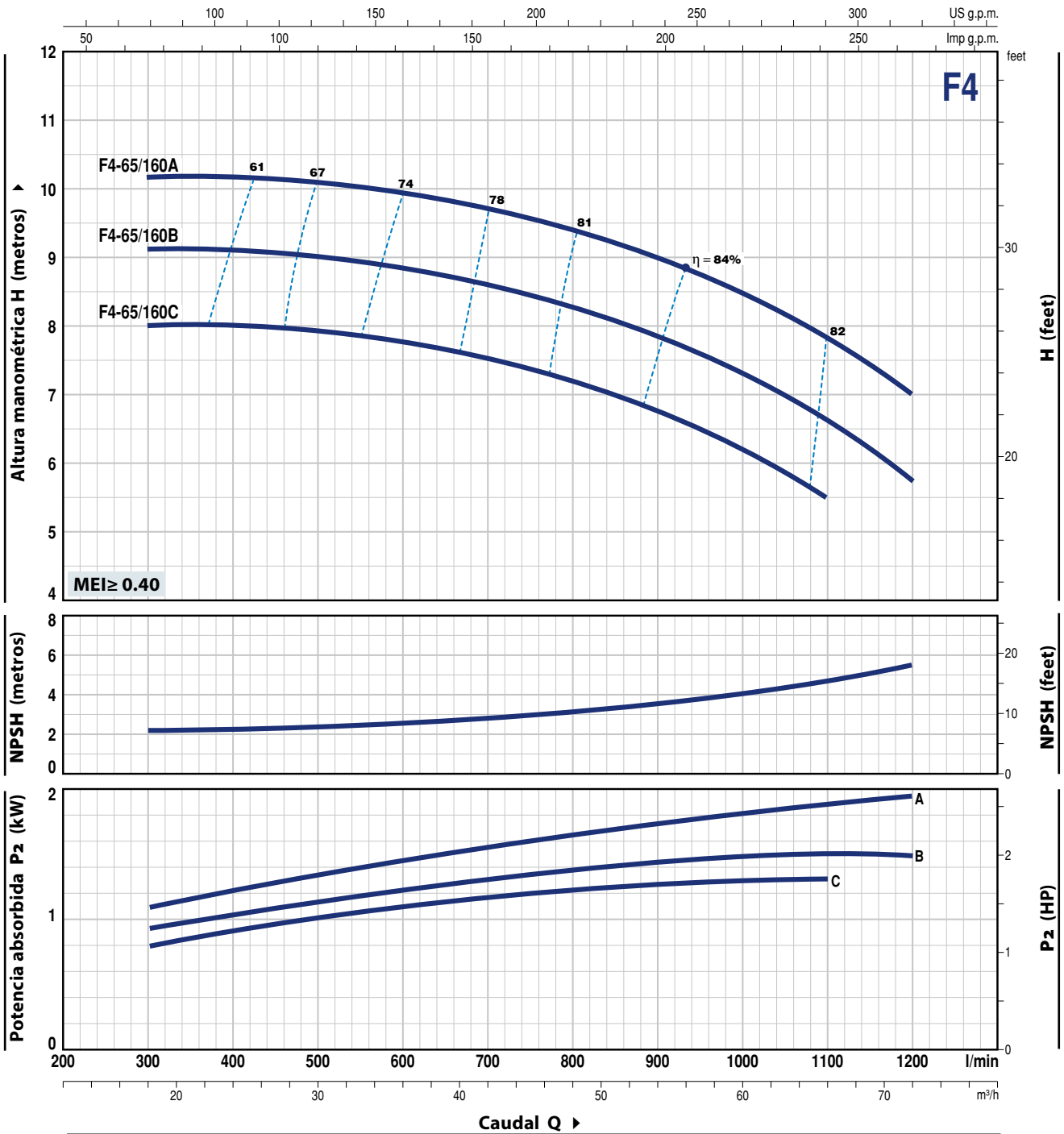

MODELO	POTENCIA (P <sub>2</sub> )		Q	Caudal											
	kW	HP		m <sup>3</sup> /h	18	24	30	36	42	48	54	60	66	72	
Trifásica			l/min	300	400	500	600	700	800	900	1000	1100	1200		
F4-65/160C	1.1	1.5	H metros	8	8	7.9	7.7	7.5	7.2	6.7	6.2	5.5			
F4-65/160B	1.5	2		9.1	9.1	9	8.8	8.6	8.3	7.8	7.3	6.6	5.7		
F4-65/160A	2.2	3		10.1	10.1	10.1	9.9	9.7	9.4	9	8.5	7.8	7		

Q=Caudal H=Altura manométrica total HS= Altura de aspiración

Tolerancia de las curvas de prestación según EN ISO 9906 Grado 3B.

## CURVAS Y DATOS DE PRESTACIONES

50 Hz n = 1450 min<sup>-1</sup> HS = 0 m

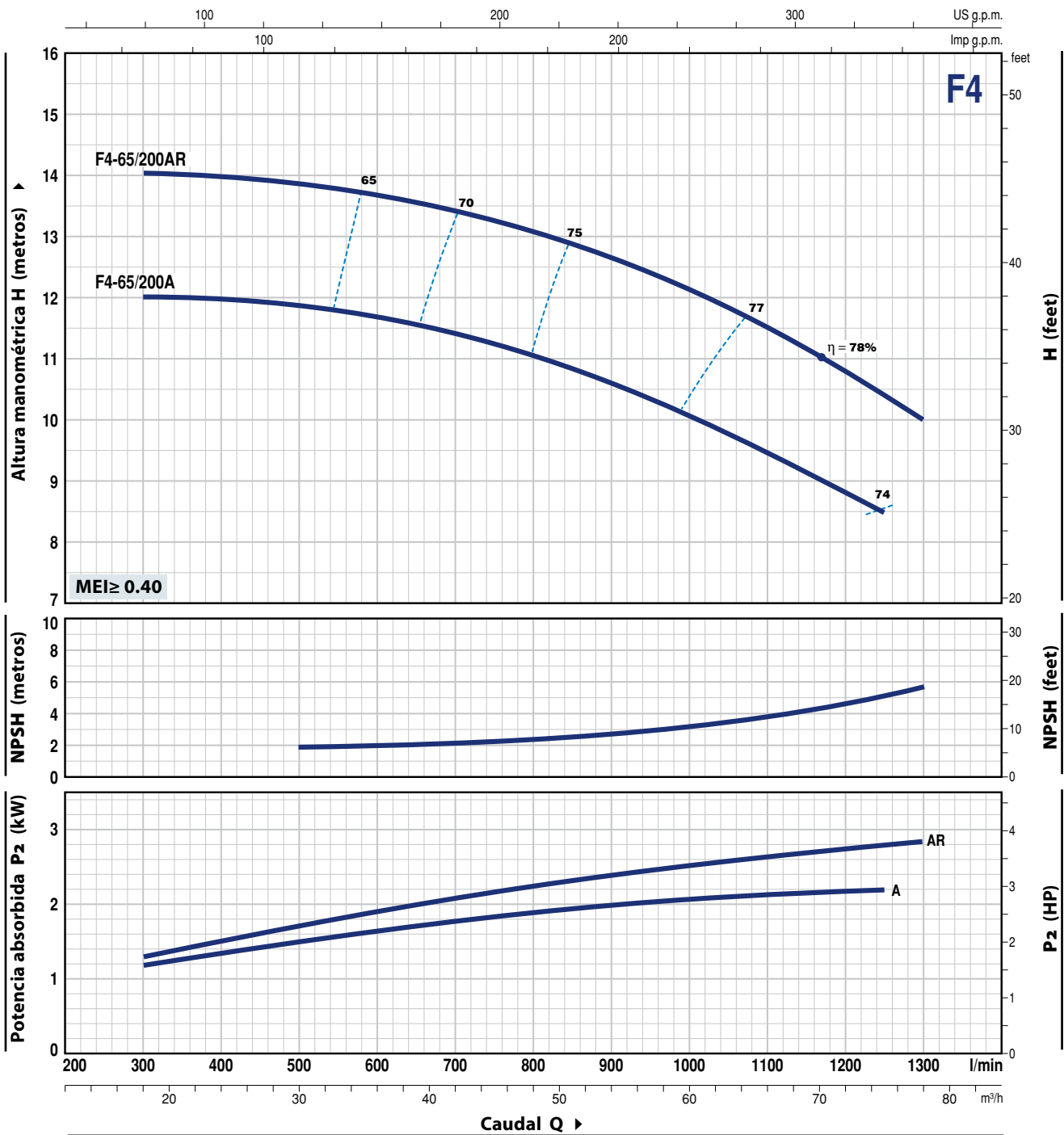

MODELO	POTENCIA (P <sub>2</sub> )		Q	Flow Rate (m³/h)														
	kW	HP		18	24	30	36	42	48	54	60	66	72	75	78			
Trifásica			Q	300	400	500	600	700	800	900	1000	1100	1200	1250	1300			
F4-65/200A	2.2	3	H metros	12	12	11.9	11.6	11.4	11	10.6	10.1	9.5	8.8	8.5				
F4-65/200AR	3	4	H metros	14	13.9	13.8	13.6	13.4	13.1	12.7	12.1	11.5	10.8	10.3	10			

Q = Caudal H = Altura manométrica total HS = Altura de aspiración

Tolerancia de las curvas de prestación según EN ISO 9906 Grado 3B.



# F4-65/250

## CURVAS Y DATOS DE PRESTACIONES

50 Hz n = 1450 min<sup>-1</sup> HS = 0 m

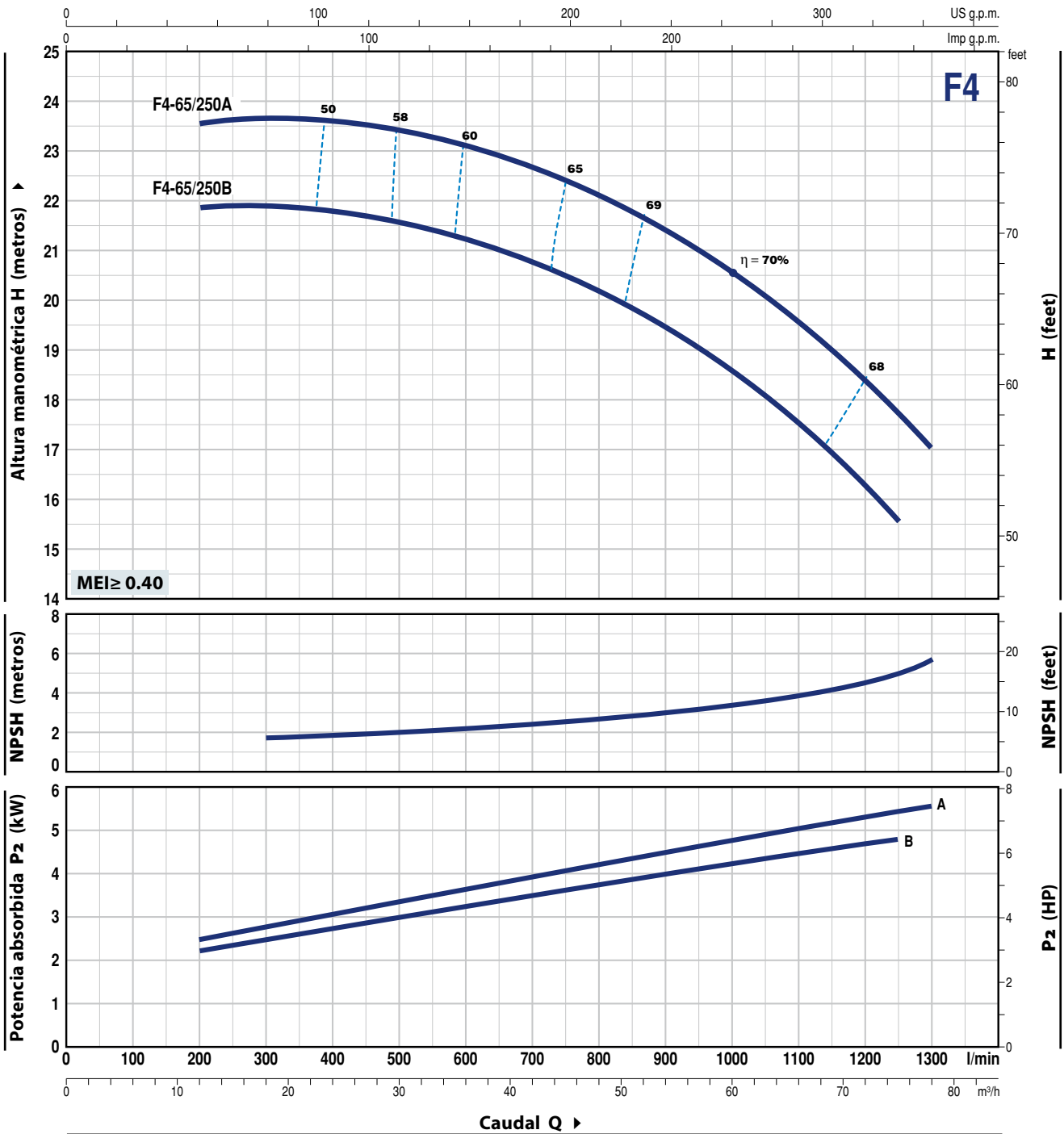

MODELO	POTENCIA (P <sub>2</sub> )		Q	Flow Rate													
	kW	HP		m <sup>3</sup> /h	12	18	24	30	36	42	48	54	60	66	72	75	78
Trifásica			l/min	200	300	400	500	600	700	800	900	1000	1100	1200	1250	1300	
F4-65/250B	4	5.5	H metros	21.8	21.8	21.7	21.5	21.2	20.7	20.2	19.5	18.6	17.5	16.2	15.5		
F4-65/250A	5.5	7.5		23.5	23.5	23.5	23.4	23.1	22.6	22.1	21.5	20.5	19.6	18.5	17.8	17	

Q = Caudal H = Altura manométrica total HS = Altura de aspiración

Tolerancia de las curvas de prestación según EN ISO 9906 Grado 3B.

## CURVAS Y DATOS DE PRESTACIONES

50 Hz n = 1450 min<sup>-1</sup> HS = 0 m

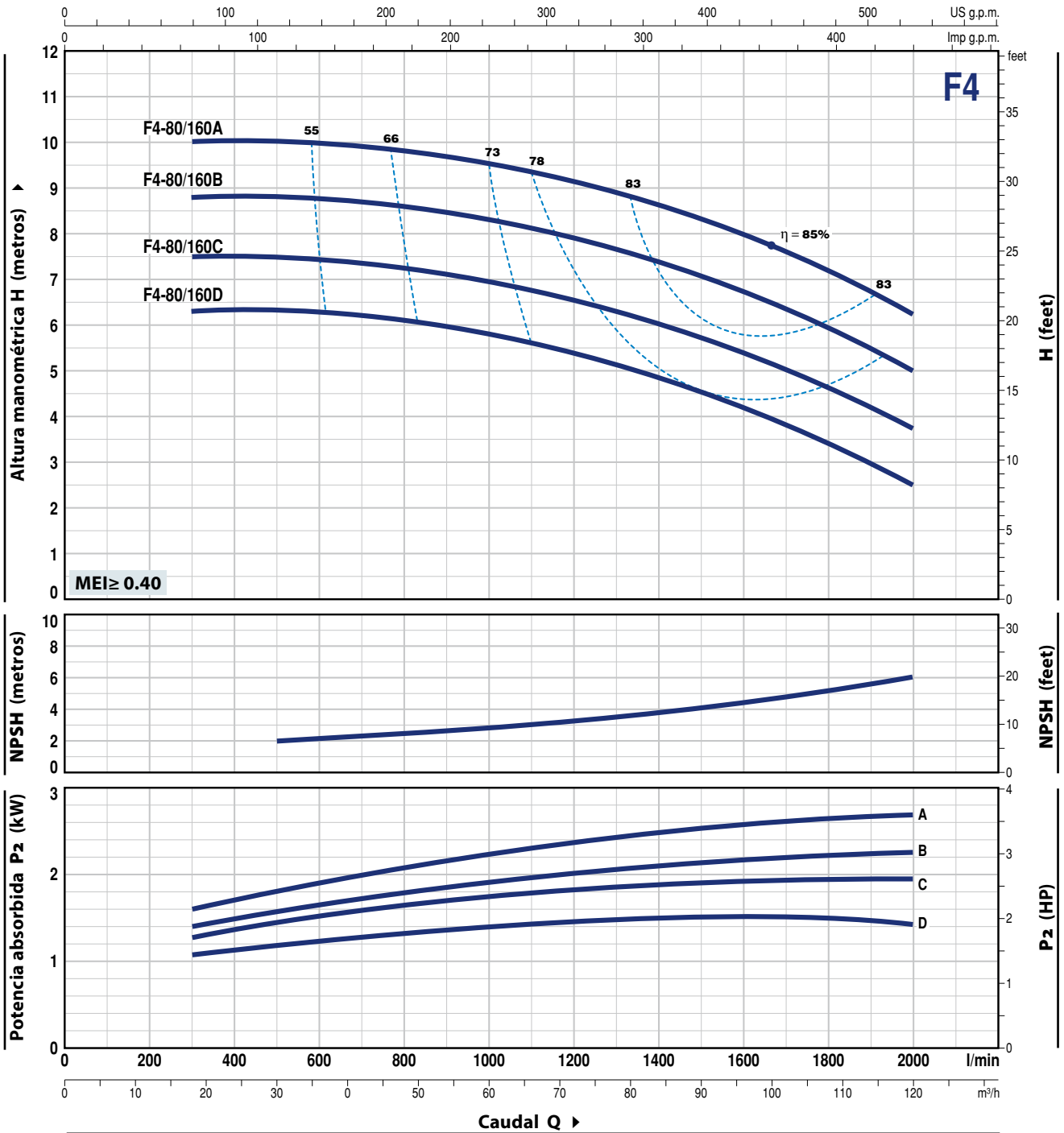

MODELO	POTENCIA (P <sub>2</sub> )		Q	H metros											
	kW	HP		m <sup>3</sup> /h	18	24	36	48	60	72	84	96	108	120	
Trifásica			l/min	300	400	600	800	1000	1200	1400	1600	1800	2000		
F4-80/160D	1.5	2		6.3	6.3	6.3	6.1	5.8	5.4	4.8	4.2	3.4	2.5		
F4-80/160C	2.2	3		7.5	7.5	7.4	7.3	6.9	6.5	6	5.4	4.6	3.8		
F4-80/160B	2.2	3		8.8	8.8	8.8	8.6	8.3	7.9	7.4	6.7	5.9	5		
F4-80/160A	3	4		10	10	10	9.8	9.5	9.1	8.6	8	7.2	6.2		

Q = Caudal H = Altura manométrica total HS = Altura de aspiración

Tolerancia de las curvas de prestación según EN ISO 9906 Grado 3B.

# F4-80/200

## CURVAS Y DATOS DE PRESTACIONES

50 Hz n = 1450 min<sup>-1</sup> HS = 0 m

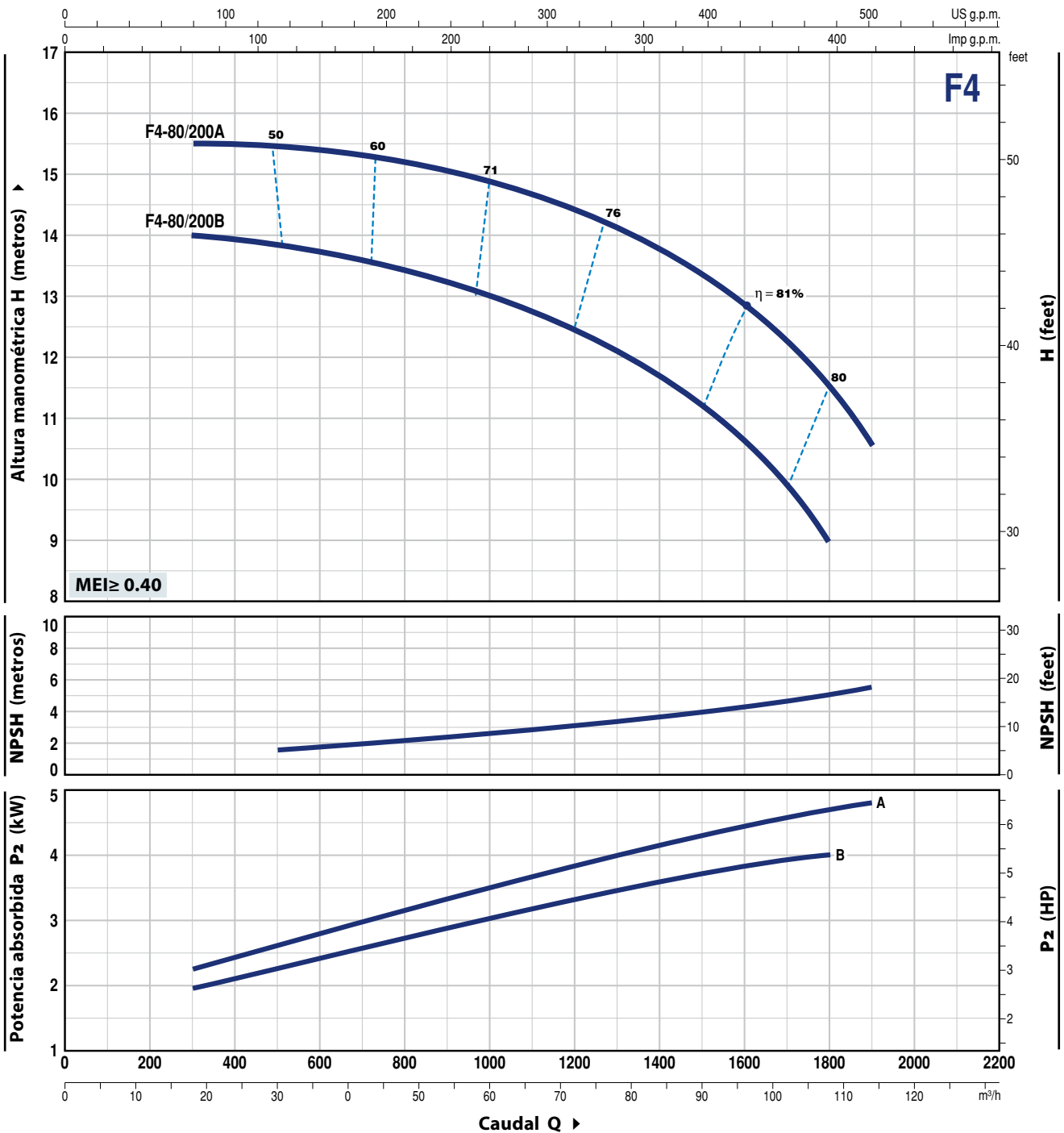

MODELO	POTENCIA (P <sub>2</sub> )		Q	Flow Rate (m³/h)											
	kW	HP		18	24	36	48	60	72	84	96	108	114		
Trifásica			l/min	300	400	600	800	1000	1200	1400	1600	1800	1900		
F4-80/200B	4	5.5	H metros	14	13.9	13.7	13.4	13	12.5	11.7	10.6	9			
F4-80/200A	5.5	7.5		15.5	15.5	15.4	15.2	14.8	14.5	13.7	12.8	11.5	10.5		

Q = Caudal H = Altura manométrica total HS = Altura de aspiración

Tolerancia de las curvas de prestación según EN ISO 9906 Grado 3B.

## CURVAS Y DATOS DE PRESTACIONES

50 Hz n = 1450 min<sup>-1</sup> HS = 0 m

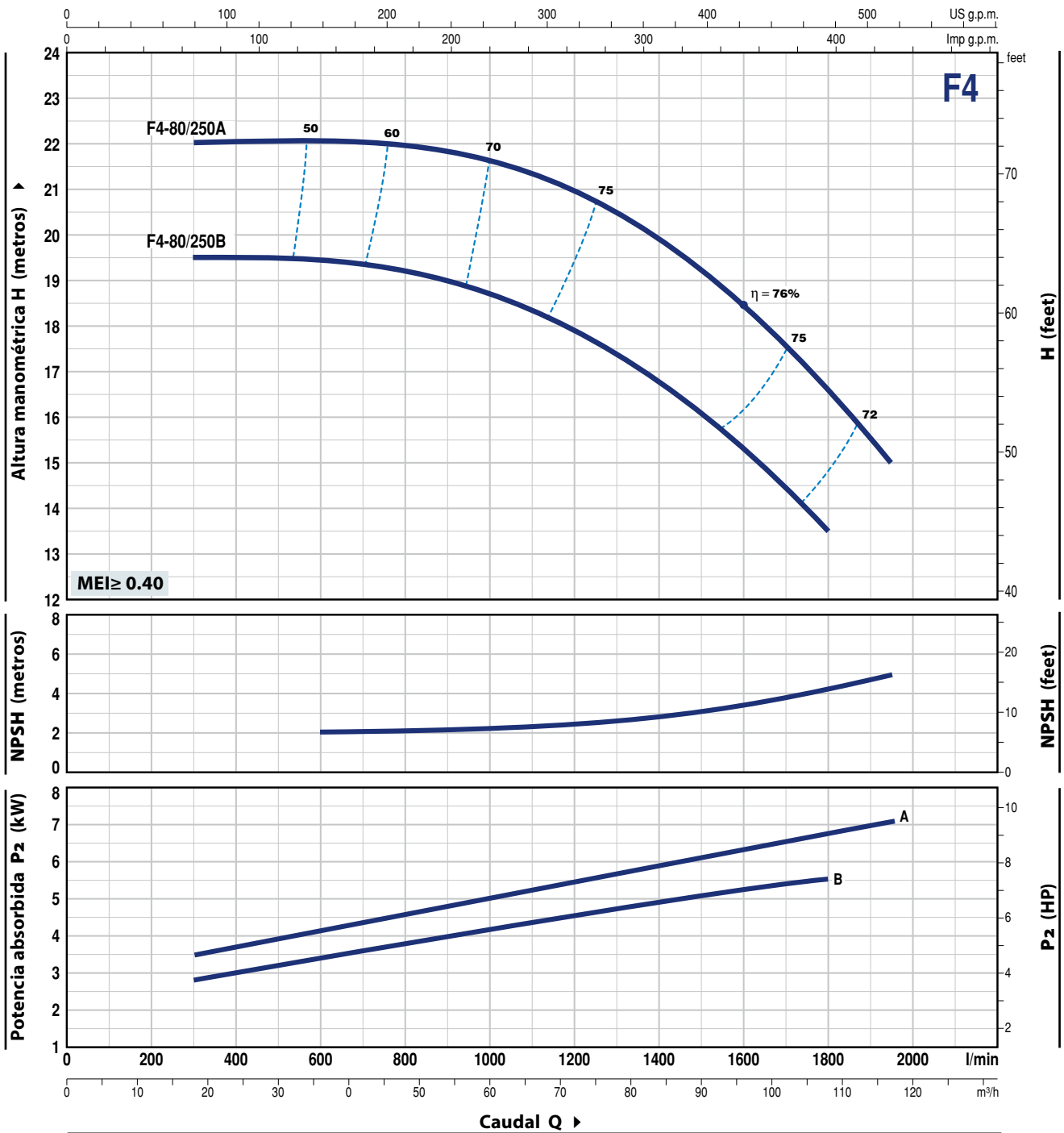

MODELO	POTENCIA (P <sub>2</sub> )		Q	Flow Rate (m³/h)												
	kW	HP		18	24	36	48	60	72	84	96	108	117			
Trifásica				300	400	600	800	1000	1200	1400	1600	1800	1950			
F4-80/250B	5.5	7.5	H metros	19.5	19.5	19.5	19.2	18.7	17.9	16.7	15.3	13.5				
F4-80/250A	7.5	10		22	22	22	21.9	21.6	21	20	18.5	16.5	15			

Q = Caudal H = Altura manométrica total HS = Altura de aspiración

Tolerancia de las curvas de prestación según EN ISO 9906 Grado 3B.

# F4-100/160

## CURVAS Y DATOS DE PRESTACIONES

50 Hz n = 1450 min<sup>-1</sup> HS = 0 m

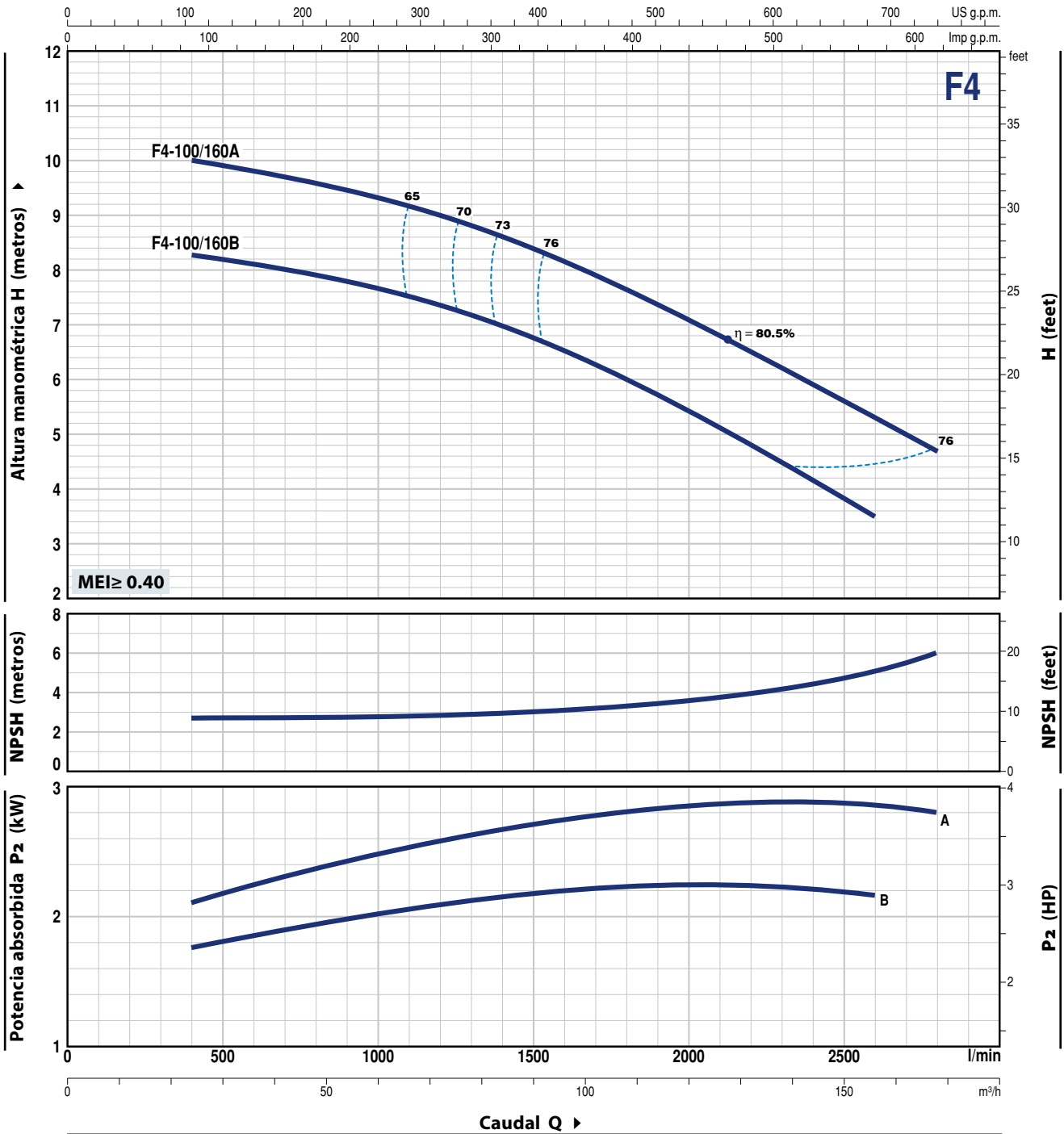

MODELO	POTENCIA (P <sub>2</sub> )		Q	Flow Rate										
	kW	HP		m <sup>3</sup> /h	24	48	72	96	120	144	156	168		
Trifásica			l/min	400	800	1200	1600	2000	2400	2600	2800			
F4-100/160B	2.2	3	H metros	8.3	8	7.5	6.5	5.5	4.2	3.5				
F4-100/160A	3	4		10	9.5	9	8	7	6	5.2	4.7			

Q = Caudal H = Altura manométrica total HS = Altura de aspiración

Tolerancia de las curvas de prestación según EN ISO 9906 Grado 3B.

## CURVAS Y DATOS DE PRESTACIONES

50 Hz n = 1450 min<sup>-1</sup> HS = 0 m

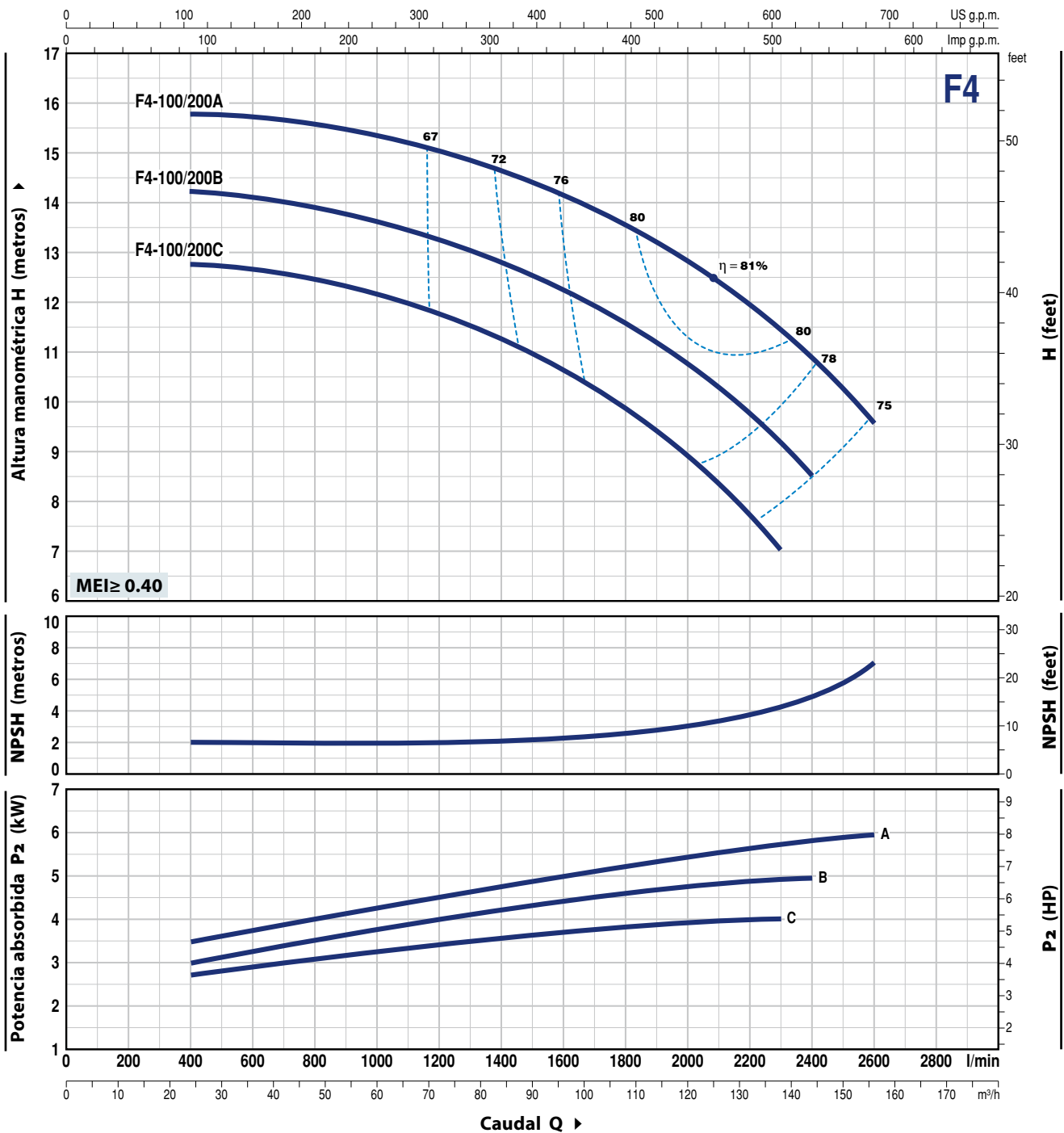

MODELO	POTENCIA (P <sub>2</sub> )		Q	Flow Rate (m³/h)														
	kW	HP		24	36	48	60	72	84	96	108	120	138	144	156			
Trifásica	kW	HP	l/min	400	600	800	1000	1200	1400	1600	1800	2000	2300	2400	2600			
F4-100/200C	4	5.5	H metros	12.7	12.6	12.5	12.2	11.8	11.3	10.6	9.9	8.9	7					
F4-100/200B	5.5	7.5		14.2	14.1	13.9	13.6	13.3	12.8	12.2	11.6	10.7	9.2	8.5				
F4-100/200A	5.5	7.5		15.8	15.7	15.6	15.4	15	14.6	14.2	13.5	12.8	12	11.4	9.5			

Q = Caudal H = Altura manométrica total HS = Altura de aspiración

Tolerancia de las curvas de prestación según EN ISO 9906 Grado 3B.

# F4-100/250

## CURVAS Y DATOS DE PRESTACIONES

50 Hz n = 1450 min<sup>-1</sup> HS = 0 m

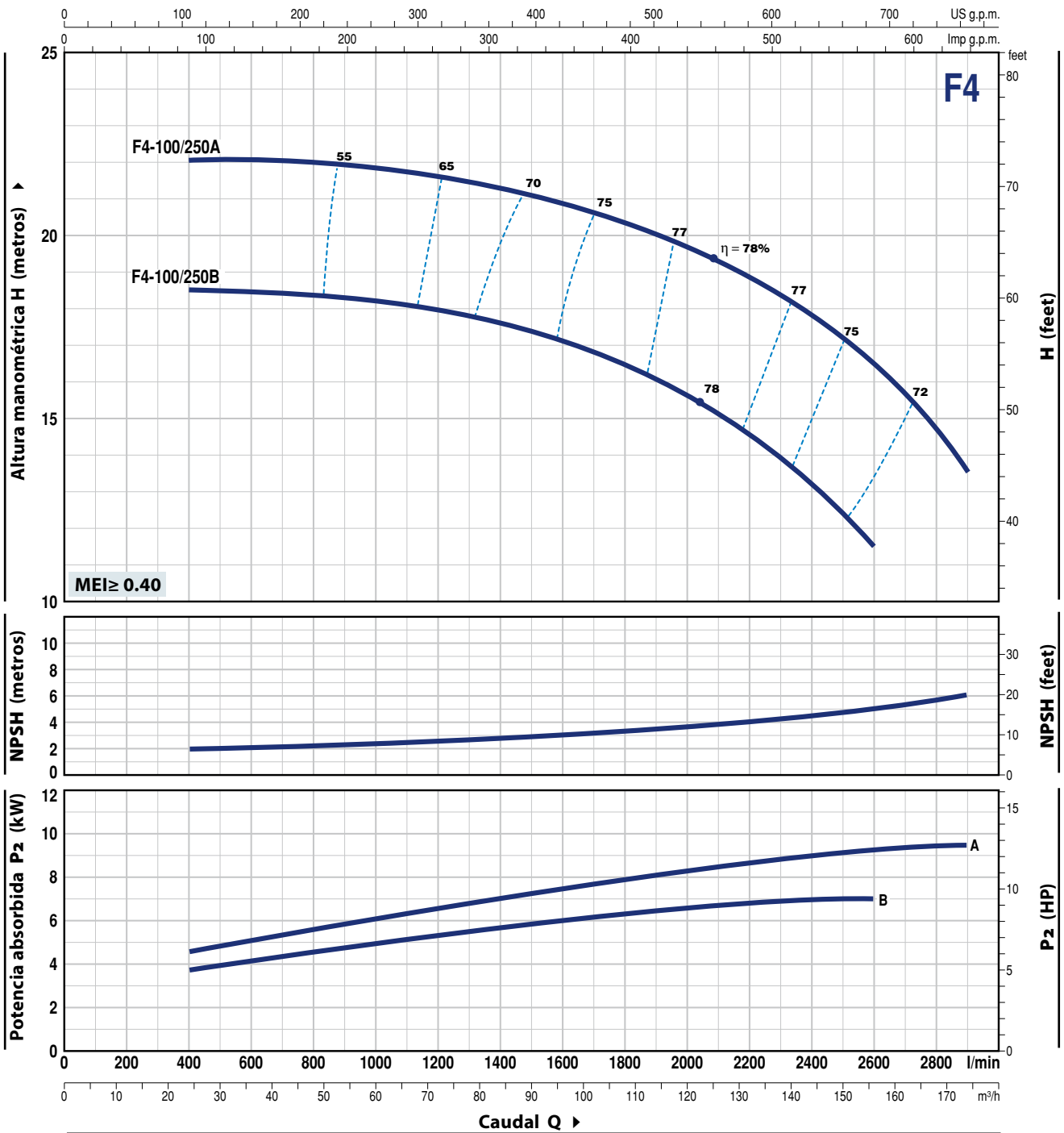

MODELO	POTENCIA (P <sub>2</sub> )		Q	Flow Rate (m <sup>3</sup> /h)														
	kW	HP		24	36	48	60	72	84	96	108	120	132	144	156	174		
Trifásica			l/min	400	600	800	1000	1200	1400	1600	1800	2000	2200	2400	2600	2900		
F4-100/250B	7.5	10	H metros	18.5	18.5	18.3	18.2	18	17.5	17.1	16.5	15.7	14.5	13.2	11.5			
F4-100/250A	9.2	12.5		22	22	22	21.8	21.6	21.2	20.9	20.3	19.7	18.9	17.9	16.5	13.5		

Q = Caudal H = Altura manométrica total HS = Altura de aspiración

Tolerancia de las curvas de prestación según EN ISO 9906 Grado 3B.

## POS. COMPONENTE CARACTERISTICAS CONSTRUCTIVAS

<b>1 CUERPO BOMBA</b>	Hierro fundido con bocas de aspiración e impulsión con bridas					
<b>2 TAPA</b>	Hierro fundido					
<b>3 RODETE</b>	Latón para F4-32/160, 32/200, 40/160, 40/200, 50/125, 50/160					
<b>4 EJE MOTOR</b>	Acero inoxidable AISI 431					
<b>5 SELLO MECANICO</b>	<b>Electrobomba</b>	<b>Sello</b>	<b>Eje</b>	<b>Materiales</b>		
	<b>Modelo</b>	<b>Modelo</b>	<b>Diámetro</b>	<i>Anillo fijo</i>	<i>Anillo móvil</i>	<i>Elastómero</i>
	F4-32/160 F4-50/125 F4-40/160	<b>FN-20</b>	<b>Ø 20 mm</b>	Grafito	Cerámica	NBR
	F4-32/200 F4-50/160 F4-40/200 F4-65/125	<b>FN-24</b>	<b>Ø 24 mm</b>	Grafito	Cerámica	NBR
	F4-50/200 F4-80/160 F4-65/200 F4-100/160 F4-65/160	<b>FN-32 NU</b>	<b>Ø 32 mm</b>	Grafito	Cerámica	NBR
	F4-32/250 F4-50/250 F4-40/250	<b>FN-38</b>	<b>Ø 38 mm</b>	Grafito	Cerámica	NBR
	F4-65/250 F4-100/200 F4-80/200	<b>FN-40 NU</b>	<b>Ø 40 mm</b>	Grafito	Cerámica	NBR
	F4-80/250 F4-100/250	<b>FH-45 NU</b>	<b>Ø 45 mm</b>	Grafito	Cerámica	NBR
<b>6 RODAMIENTOS</b>	<b>Electrobomba</b>	<b>Modelo</b>	<b>Electrobomba</b>	<b>Modelo</b>		
	F4-32/160 F4-40/160 F4-50/125	<b>6206 ZZ-C3 / 6204 ZZ</b>	F4-32/250 F4-40/250 F4-50/200 F4-50/250 F4-65/160 F4-65/200 F4-80/160 F4-100/160	<b>6208 ZZ-C3 / 6206 ZZ-C3</b>		
	F4-32/200 F4-40/200 F4-50/160 F4-65/125	<b>6307 ZZ-C3 / 6206 ZZ-C3</b>	F4-65/250 F4-80/200 F4-80/250 F4-100/200 F4-100/250	<b>6310 ZZ-C3 / 6308 ZZ-C3</b>		
<b>7 MOTOR ELECTRICO</b>	<b>F4: a 4 polos trifásica 230/400 V - 50 Hz</b> <b>Las electrobombas están equipadas con motores de alto rendimiento en clase IE2 hasta P<sub>2</sub>=0.37 kW y en clase IE3 desde P<sub>2</sub>=0.75 kW (IEC 60034-30-1)</b> – Aislamiento: clase F – Protección: IP 55					

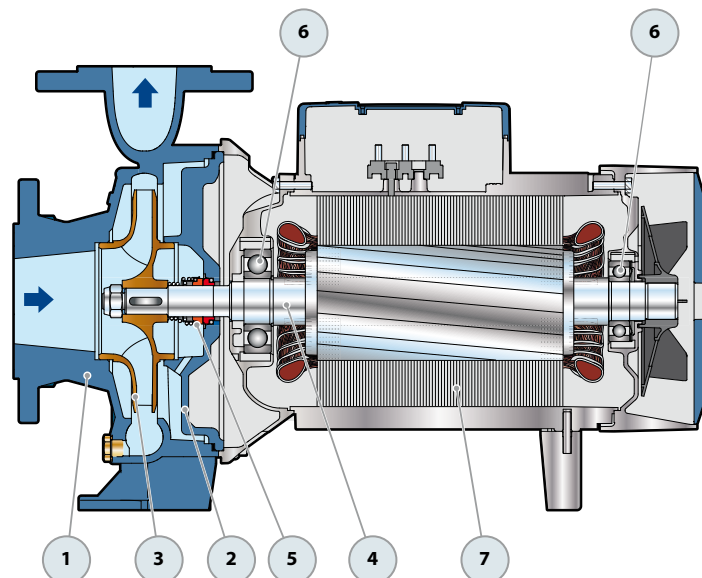



## DIMENSIONES Y PESOS

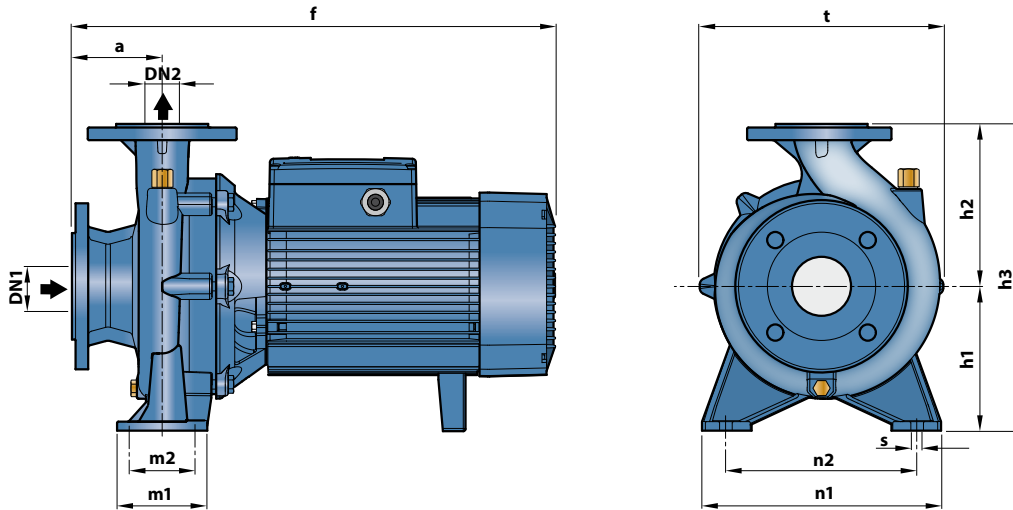

MODELO	DIMENSIONES mm													kg															
Trifásica	DN1	DN2	a	f	h3	h1	h2	t	n2	n1	m1	m2	s																
F4-32/160B	50	32	80	412	292	132	160	242	190	240	100	70	14	31.2															
F4-32/160A																31.2													
F4-32/200B																	43.4												
F4-32/200A																	43.5												
F4-32/200BH					100	469	340	160	180	270				95		42.3													
F4-32/200AH																42.4													
F4-32/250C						522	405	180	225	330	250	320		125	95	64.1													
F4-32/250B						568										63.1													
F4-32/250A												68.7																	
F4-40/160B	65	40	80	412	292	132	160	240	190	240	100	70	14	32.5															
F4-40/160A															32.9														
F4-40/200B																46.0													
F4-40/200A																46.2													
F4-40/250C					100	489	340	160	180	275	212	265		100	70	59.7													
F4-40/250B						522	405	180	225	328	250	320		125	95	60.1													
F4-40/250A						568										72.4													
F4-50/125B						431	292	132	160	242	190	240					32.2												
F4-50/125A			100	489	340	160	180	269	212	265	100	70	14	44.4															
F4-50/160B							200	316													59.2								
F4-50/160A							529	360													68.3								
F4-50/200C							576														68.5								
F4-50/200B				522	360	180	225	337	250	320				125	95	18	68.8												
F4-50/200A																	568									59.9			
F4-50/250D																										63.3			
F4-50/250C																										68.7			
F4-50/250B													69.1																
F4-50/250A													78.0																
F4-50/250AR																													
F4-65/125B	80	65	100	511	340	160	180	291	212	280	125	95	14	50.2															
F4-65/125A																							50.4						
F4-65/160C														533	360		200	300						55.0					
F4-65/160B														579										58.7					
F4-65/160A						582	405	180	225	340				250	320	160	120	18	65.0										
F4-65/200A																			627	450	200	250	373	280	360			72.0	
F4-65/200AR																													78.4
F4-65/250B																													111.2
F4-65/250A													139.6																
F4-80/160D	100	80	125	565	405	180	225	330	250	320	125	95	14	65.8															
F4-80/160C																						67.3							
F4-80/160B																							70.0						
F4-80/160A																				76.4									
F4-80/200B						655	430	200	250	360	280	345		160	120	18	100.0												
F4-80/200A									673	480	280	405		315	400					130.2									
F4-80/250B																					149.5								
F4-80/250A																					137.6								
F4-100/160B	125	100	125	622	480	200	280	362	280	360	160	120	18	91.0															
F4-100/160A																								97.0					
F4-100/200C																									122.0				
F4-100/200B															657	480	225	280	422	315	400	315	400	18	116.0				
F4-100/200A						694																						124.1	
F4-100/250B						789																							143.0
F4-100/250A																													159.3

## BRIDAS DE LAS BOCAS

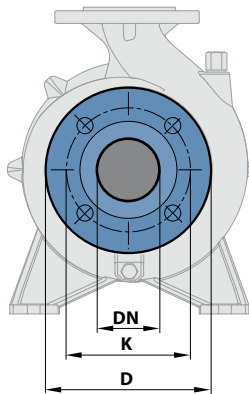

## CONTOBRIDAS

(SE PUEDE PEDIR A PARTE)

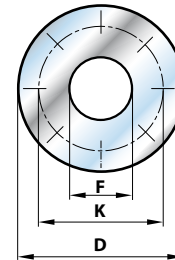

DN BRIDAS mm	D mm	K mm	ORIFICIOS	
			N°	Ø (mm)
32	140	100	4	18
40	150	110		
50	165	125		
65	185	145		
80	200	160	8	
100	220	180		
125	250	210		

DN BRIDAS mm	F CONTOBRIDAS	D mm	K mm	ORIFICIOS	
				N°	Ø (mm)
32	1¼"	140	100	4	18
40	1½"	150	110		
50	2"	165	125		
65	2½"	185	145		
80	3"	200	160	8	
100	4"	220	180		
125	5"	250	210		

## CONSUMO EN AMPERIOS

MODELO	TENSION	
	230-240 V	400-415 V
<b>Trifásica</b>		
F4-32/160B	1.9 A	1.1 A
F4-32/160A	1.9 A	1.3 A
F4-32/200B	3.6 A	2.1 A
F4-32/200A	4.0 A	2.3 A
F4-32/200BH	3.3 A	1.9 A
F4-32/200AH	3.5 A	2.0 A
F4-32/250C	5.7 A	2.6 A
F4-32/250B	7.3 A	3.3 A
F4-32/250A	7.8 A	5.2 A
F4-40/160B	2.1 A	1.2 A
F4-40/160A	2.8 A	1.6 A
F4-40/200B	3.6 A	2.1 A
F4-40/200A	4.2 A	2.4 A
F4-40/250C	5.5 A	2.6 A
F4-40/250B	6.1 A	3.5 A
F4-40/250A	8.5 A	5.2 A
F4-50/125B	2.3 A	1.4 A
F4-50/125A	2.6 A	1.5 A
F4-50/160B	3.3 A	2.1 A
F4-50/160A	4.2 A	2.4 A
F4-50/200C	6.1 A	3.5 A
F4-50/200B	8.0 A	4.6 A
F4-50/200A	9.0 A	5.2 A
F4-50/200AR	10.6 A	6.8 A
F4-50/250D	4.9 A	2.8 A
F4-50/250C	5.9 A	3.4 A
F4-50/250B	8.5 A	4.9 A
F4-50/250A	9.9 A	5.7 A
F4-50/250AR	11.8 A	6.8 A

MODELO	TENSION	
	230-240 V	400-415 V
<b>Trifásica</b>		
F4-65/125B	3.6 A	2.1 A
F4-65/125A	4.5 A	2.6 A
F4-65/160C	5.2 A	2.7 A
F4-65/160B	5.9 A	3.4 A
F4-65/160A	7.8 A	4.5 A
F4-65/200A	9.0 A	5.2 A
F4-65/200AR	11.8 A	6.8 A
F4-65/250B	17.3 A	9.5 A
F4-65/250A	21.7 A	13.5 A
F4-80/160D	5.9 A	3.4 A
F4-80/160C	8.1 A	4.7 A
F4-80/160B	9.2 A	5.3 A
F4-80/160A	10.6 A	6.8 A
F4-80/200B	13.8 A	9.5 A
F4-80/200A	18.2 A	12.8 A
F4-80/250B	20.8 A	13.5 A
F4-80/250A	25.6 A	14.8 A
F4-100/160B	9.0 A	5.2 A
F4-100/160A	11.2 A	6.5 A
F4-100/200C	14.2 A	9.5 A
F4-100/200B	17.8 A	12.1 A
F4-100/200A	20.8 A	13.5 A
F4-100/250B	26.8 A	15.9 A
F4-100/250A	34.1 A	19.7 A